

**The Camden (Revocation of Parking Places) (No. \*\*) Traffic Order 202\***  
**The Camden (Parking Places) (Dedicated Disabled) (Amendment No. \*\*) Traffic Order 202\***  
**The Camden (Free Parking Places) (Disabled Persons) (Amendment No. \*) Traffic Order 202\***  
**The Camden (Waiting and Loading Restrictions) (Civil Enforcement Area) (Amendment No. \*\*) Traffic Order 202\***  
**The Camden (Taxi Stopping Areas) (No. \*) Traffic Order 202\***  
**The Camden (Loading Places) (Amendment No. \*) Traffic Order 202\***

Notice is hereby given that the Council of the London Borough of Camden ('the Council') propose to make the above Orders under sections 6, 45, 46, 49 and 124 of and Part IV of Schedule 9 to the Road Traffic Regulation Act 1984, as amended. The general nature and effect of the Orders would be as set out below and to make other minor amendments to the orders to better reflect how restrictions currently exist on street:

**Agamemnon Road** – opposite nos. 64 and 66, remove 10.3 metres of 'CA-P' permit holders parking place and replace it with double yellow line; **Agincourt Road** – outside no. 87, convert 10.3 metres of single yellow line to double yellow line; **Bedford Row** – (i) in the north-west to south-east arm, on the south-west side, remove the south-easternmost 6.1 metres of 'CA-D' resident permit parking place outside No. 44 Bedford Row, to be replaced by no waiting and no loading 'at any time' restrictions (to be indicated by double yellow line and double kerb marks) and (ii) impose no waiting and no loading 'at any time' restrictions around the junction of Bedford Row (east to west arm), Bedford Road (north-west to south-east arm) and Sandland Street, extending east into Bedford Row (east to west arm) for 2.9 metres and into Bedford Row (north-west to south-east arm) on the south-west side for 14 metres (including the length described above) and on the north-east side for 21.9 metres; **Ferncroft Avenue** – outside the drive of 53 Hollycroft Avenue, extend the existing single yellow line by 1 metre by shortening two 'CA-S' permit holders parking places by 0.5 metres each; **Grafton Road** – outside nos. 3 and 5, convert the existing 'dedicated disabled' parking place to a disabled persons 'blue badge' parking place; **Gresse Street** – (i) remove the north-westernmost 10 metres of 'CA-C' resident permit parking place, to be replaced by 5 metres of double yellow line and 5 metres of pedal cycle parking stands; and (ii) opposite no. 17, convert 10.6 metres of existing single yellow line to double yellow line; and (iii) outside no. 24, extend the existing 'CA-C' resident permit parking place north-westwards by 5 metres; **High Holborn** – convert the existing loading place outside the Shaftesbury Theatre so that it operates as a loading place for goods vehicles between 8:30am and 6:30pm and as a stopping area for taxis overnight between 6:30pm and 8:30am; **Iverson Road** – (i) adjacent to no. 128 convert the south-westernmost 6.6 metres of 'CA-Q' permit parking place to a disabled persons 'blue badge' parking place; (ii) outside no. 158, convert the existing disabled persons 'blue badge' parking place to 'CA-Q' permit parking place; (iii) outside no. 137, convert the south-westernmost 6.6 metres of 'CA-Q' permit parking place to a 'dedicated disabled' parking place; and (iv) outside 25 Iverson Road (the builders and plumbers merchant), replace 27.6 metres of single yellow line with double yellow line; **Kingsgate Place** – across the access road at the rear of 42-53 Eresby Place, convert the existing single yellow line to a no waiting or loading at any time restriction (to be indicated by a double yellow line and double kerb marks); **Lamble Street** – on the south-east side, opposite the side of No. 1 Oak Village, remove the north-easternmost 7.2 metres of 'CA-L' permit parking place and replace it with double yellow line; **Leverton Street** – (i) at the side of no. 13 Falkland Road, remove the southernmost 2.7 metres of 'CA-M' permit parking place and replace it with a no waiting or loading at any time restriction and extend that parking place northwards by replacing 6.2 metres of single yellow line; and (ii) at the side of no. 15 Falkland Road, remove the southernmost 4.8 metres of 'CA-M' permit parking place and replace it with a no waiting at any time restriction; **Loveridge Road** – outside no. 84, convert the existing 'dedicated disabled' parking place to a disabled persons 'blue badge' parking place; **Mansfield Road** – outside nos. 4 to 8, convert 18.6 metres of single yellow line to double yellow line; **Netherhall Gardens** – outside nos. 38 and 40, across the vehicular accesses convert one 4.7 metre length and one 4.9 metre length of single yellow line to double yellow line; **Prince Arthur Road** – (i) on the south-east side, remove the 'CA-H' resident permit holders parking place and replace it with double yellow line; and (ii) on the north-west side, at the side of 79 Fitzjohn's Avenue, extend the existing 'CA-H' resident permit holders parking place by replacing 5 metres of double yellow line at its north-eastern end; **Sandland Street** – on both sides, ban waiting (including waiting for the purposes of loading) at any time around its junction with Bedford Row; **Willow Road** – outside no. 54, add 15.2 metres of 'no loading at any time' restrictions (to be indicated by double kerb marks) to the existing double yellow line.

*N.B. Each disabled persons 'blue badge' parking place would operate at any time and may be used by any vehicle displaying a valid disabled persons 'blue badge' while each 'dedicated disabled' parking place would operate at any time and be reserved for the use of a specific disabled resident.*

Copies of the proposed Orders, a plan indicating the proposals, and other documents relating to the Orders may be obtained by contacting [traffic.orders@camden.gov.uk](mailto:traffic.orders@camden.gov.uk) or inspected either: online at [camden.gov.uk/recently-advertised-proposals](https://camden.gov.uk/recently-advertised-proposals) or by prior appointment, in person at 5 Pancras Square, London, N1C 4AG during normal office hours. Any person wishing to object or make representations in respect of the proposed Orders should send comments in writing, giving reasons for any objection to the e-mail address above, or by post to FREEPOST LBC TRANSPORT STRATEGY, to be received by the end of 29 March 2024.

**Peter Mardell** – Head of Parking Operations  
7 March 2024

## STATEMENT OF REASONS

### **Disabled Bays**

#### Grafton Road

The purpose of this proposal is to convert the existing dedicated disabled bay outside Nos. 3 and 5 Grafton Road, which has been notified as no longer required, to a general disabled bay for use by any blue badge holders.

#### Iverson Road

The purpose of this proposal is to:

- convert 6.6 metres of resident permit holder (CPZ CA-Q) parking to a dedicated disabled parking bay outside 137 Iverson Road, for the applicants sole use.
- convert the existing general disabled bay outside No 158 Iverson Road to a resident permit holder space (CPZ CA-Q).
- convert 6.6 metres of resident permit holder (CPZ CA-Q) parking space to general disabled parking bay adjacent to 128 Iverson Road, for use by any blue badge holders.

#### Loveridge Road

The purpose of this proposal is to convert the existing dedicated disabled bay outside No. 84 Loveridge Road, which has been notified as no longer required, to a general disabled bay for use by any blue badge holders.

The above proposals meet the aims of 'We Make Camden' by improving the quality of life for the user of the proposed disabled bays, enabling them to live a more independent and active life.

The proposals meet the objectives of Camden Transport Strategy (CTS) which acknowledges that people who have a disability can have particular difficulties when they are travelling by public transport, and walking and cycling may be difficult, unsuitable, or simply not an option.

### **General Minor Parking Amendments**

#### Agamemnon Road

The purpose of this proposal is to improve manoeuvrability and safety for large vehicles such as those used by the council's refuse service by:

- converting 10.3m of permit holders only parking bays on Agamemnon Road (opposite house numbers 66 & 68) into double yellow lines ('No Waiting At Any Time') restrictions.

The above proposal meets the objectives of the Camden Transport Strategy (CTS) and Road Safety Action Plan by improving safety and access at the turn of the street, by larger vehicles including refuse trucks and fire engines.

#### Bedford Road and Sandland Street

The purpose of this proposal is to improve manoeuvrability and safety for large vehicles such as those used by the council's refuse service by:

- Removing 6.1m of resident parking bay outside 44 Bedford Row and replacing it with "no waiting and loading at all times" to ensure safe vehicle swept path. No waiting at any time restrictions to be introduced on Sandland Street outside no. 45 and 46 to ensure a large vehicle can turn left into Bedford Row as well as around the corners of the junction to improve safety and visibility.

### Ferncroft Avenue

The purpose of this proposal is to improve manoeuvrability and safety for the resident's vehicle entering and leaving Ferncroft Avenue by:

- Remove 0.5m of permit holders only parking space from both the northwest and southeast bays next to the vehicle access on Ferncroft Avenue (adjacent to house number 53) and extend the single yellow line restriction.

The above proposal meets the objectives of the Camden Transport Strategy (CTS) and Road Safety Action Plan by improving safety, visibility and accessibility egressing/ingressing off the street.

### Gresse Street

The purpose of this proposal is to improve visibility and safety for the residents crossing Gresse Street and enhance the cycle facilities by:

- remove 10 metres of Resident permit holders only parking and extend for 5 metres 'No Waiting At Any Time' restrictions to improve junction protection. Install cycle stands in the remaining 5 metres on the carriageway for additional parking.
- install dropped kerb with buff tactiles across Gresse Street at the junction with Stephen Street to provide a convenient and safe crossing point.
- convert single yellow line into double yellow lines ('No Waiting At Any Time') outside building number 24 Gresse Street to keep an existing dropped kerb clear and improve visibility for pedestrians crossing.
- remove 5 metres of single yellow line and extend Resident permit holders only space (outside building number 24 Gresse Street) for vehicle parking.

The above proposal meets the objectives of the Camden Transport Strategy (CTS) and Road Safety Action Plan by overcoming barriers and improving health by improving safety, visibility, sustainability and accessibility, to the street, between buildings and cycle parking.

### High Holborn

The purpose of this proposal is to allow goods vehicles loading only between 8.30am to 6.30pm, and taxi use only between 6:30pm and 8:30am outside the Shaftesbury Theatre, on High Holborn.

The proposal meets the aims of 'We make Camden' by making Camden the best place to do business and working with the business community to deliver genuinely inclusive growth that benefits everyone; as well as improving public transport and accessibility in the area.

### Iverson Road

The purpose of this proposal is to reduce the chances that the entrance/ exit to the business yard from being blocked by vehicles parking in front on Iverson Road and thus improving safety and visibility by:

- converting 27.6m of single yellow line into double yellow lines ('No Waiting At Any Time') restrictions on Iverson Road outside the egress/ ingress to the 'MP Moran' business yard.

The above proposal meets the objectives of the Camden Transport Strategy (CTS) by improving the safety of loading and deliveries for adjacent businesses.

### Lamble Street (Kiln Place)

The purpose of this proposal is to improve manoeuvrability and passage of larger vehicles such as e.g. a refuse, emergency service vehicles from Oak Village into Lamble Street. Also provide bollards to highlight the edge of a kerblines to reversing vehicles by:

- converting 7.2m of permit holders only parking into double yellow lines ('No Waiting At Any Time') restrictions.
- installing bollards into the southwestern kerblines of Oak Village (near Kiln Place) to signify to reversing driver of the closeness building behind.

The above proposal meets the objectives of the Camden Transport Strategy (CTS) and Road Safety Action

Plan by improving safety and access at the turn of the street, by larger vehicles including refuse trucks and fire engines.

#### Kingsgate Place, NW6 4JT

The purpose of this proposal is to prohibit vehicles from parking and obstructing access to the underground carpark for 10 Kingsgate Place by:

- converting 11.7 metres of single yellow line to no waiting and loading at any time on Kingsgate Place, in front of access road to 10 Kingsgate Place, NW6 4JT;

The proposal meets the aims of 'We make Camden' by making Camden the best place to do business and working with the business community to deliver genuinely inclusive growth that benefits everyone.

The proposal meets the programme of 'junction protection' schemes in the Camden Transport Strategy (CTS). This programme can aid businesses (where applicable) to improve the ingress/ egress to their business for their customers and improve pedestrian sightlines and reduce road danger at these locations.

#### Leverton Street (Falkland Road)

The purpose of this proposal is to improve manoeuvring and road safety for the large vehicles such as a refuse vehicles turning from Falkland Road into Leverton Street by:

- removing 4.8m of permit holders only parking and extend No Waiting At Any Time northbound, on the eastern kerblines of Leverton Street.
- remove 2.7m of permit holders only parking and extend No Waiting At Any Time restrictions northbound, on the western kerblines of Leverton Street.
- Remove redundant crossover and extend permit holders only parking bay (CPZ CA-M) northbound by 6.2m.

The above proposal meets the objectives of the Camden Transport Strategy (CTS) and Road Safety Action Plan by improving safety, manoeuvring and accessibility of large vehicles.

#### Mansfield Road and Agincourt Road

The purpose of this proposal is to reduce the chances of parked vehicles narrowing the entrance/ exit of various road arms of a signal junction. The road arms of Agincourt Road and Mansfield Road are affected on the exit and entrance respectively. The proposal looks to address this by:

- converting 10.3m of single yellow line into double yellow lines ('No Waiting At Any Time') restrictions on Agincourt Road on the exit to Mansfield Road.
- converting 18.6m of single yellow line into double yellow lines ('No Waiting At Any Time') restrictions on Mansfield Road near the exit from Agincourt Road.

The above proposal meets the objectives of the Camden Transport Strategy (CTS) and Road Safety Action Plan by improving sightlines for all modes, at the junction with Agincourt Road.

#### Netherhall Gardens

The purpose of this proposal is to reduce the chances of parked vehicles blocking the ingress/ egress into house number 38 of Netherhall Gardens by:

- converting 4.9m of single yellow line into double yellow lines ('No Waiting At Any Time') restrictions at the southwest vehicle gate.
- converting 6.3m of single yellow line into double yellow lines ('No Waiting At Any Time') restrictions at the northeast vehicle gate.

The above proposal meets the objectives of the Camden Transport Strategy (CTS) and Road Safety Action Plan by improving safety and access to the residential properties in Orestes Mews.

#### Prince Arthur Road

The purpose of this proposal is to relocate a parking space to the opposite kerblines of the Prince Arthur Road by:

- removing the parking space outside house number 77 Fitzjohn's Avenue 'The Dutch House' (entrance/ exist on Prince Arthur Road) and installing double yellow lines ('No Waiting At Any Time') restrictions in the same space (off the southeast kerbline).
- removing 5m of double yellow lines ('No Waiting At Any Time') restriction (off the northwest kerbline) next to the northeast end of the most northernly permit parking bay. Then extending this bay by 5m.

The above proposal meets the objectives of the Camden Transport Strategy (CTS) and Road Safety Action Plan by improving sightlines for all modes, at the junction with Fitzjohn's Avenue.

#### Willow Road

The purpose of this proposal is to restrict vehicles obstructing access and egress for No. 54 Willow Road, which could be required in an emergency, by:

- installing 'No waiting and loading At Any Time' for a length of 20m outside house number 54 Willow Road.

The above proposal meets the objectives of the Camden Transport Strategy (CTS) and Road Safety Action Plan by improving safety, visibility and accessibility egressing/ ingressing between dwelling and the street.



66 68

TMO

Agamemnon Road

1.2m  
10.3m

Remove parking space indicated and extend 'No Waiting At Any Time' restrictions by 10.3m

Remove permit holders only sign and post

**KEY**

-  Existing parking lines
-  Existing 'No Waiting At Any Time' restrictions
-  Remove parking lines
-  Install parking lines (TSRGD 1028.4)
-  Install 'No Waiting At Any Time' restrictions, 50mm yellow lines (TSRGD 1018.1). Colour to match existing

Rev	By	Date	Amendments

 **Camden**  
 Design Team  
 Transport Strategy Service  
 London Borough of Camden  
 5 Pancras Square  
 Tel 020 7974 5551, Fax 020 7974 6952  
 DX 2106 Euston, Minicom 020 7974 6866

Project  
Minor Parking Scheme

Drawing Title  
Parking changes  
Agamemnon Road  
Construction & TMO drawing

Scale 1:150	Date Dec 2023
Drawn By MW	File Ref
Checked By JA	Dwg Name

Drawing Location  
C:\Users\CAMM\OneDrive - London Borough of Camden\Temp\MW\Schemes\Road Safety & Minor Schemes

Drawing Number Agamemnon Rd/ 02 & 03	Rev.
---	------



6

3 to 5

2

1

BEDFORD ROW

Resident permit holders only  
CA-D CPZ  
Mon-Fri 8.30am - 6.30pm  
Sat 8.30am - 1.30pm

ENTRY

NO

6.8m

21.9m

Shortening of existing resident permit holders only parking bay

10m

6.1m

7.9m

6m

5.3m

42

44

18

SANDLAND ST

BEDFORD ROW

CAR CLUB

BIKE

HIRE

DOCKLESS

46

45

KEY

Prop. white line

Prop. double yellow line  
No waiting at any time

Parking bay removal

Rev	By	Date	Amendments

**Camden**  
 Design Team  
 Transport Strategy Service  
 London Borough of Camden  
 5 Pancras Square  
 Tel 020 7974 5551, Fax 020 7974 6952  
 DX 2106 Euston, Minicom 020 7974 6866

Project  
BEDFORD ROW

Drawing Title  
TRAFFIC MANAGEMENT ORDER

Scale 1 : 100 @ A1	Date 26 02 2024
Drawn By RW	File Ref
Checked By AC	Dwg Name
Drawing Location	

Drawing Number TS/BEDFORDROW/TMO	Rev. -
-------------------------------------	-----------

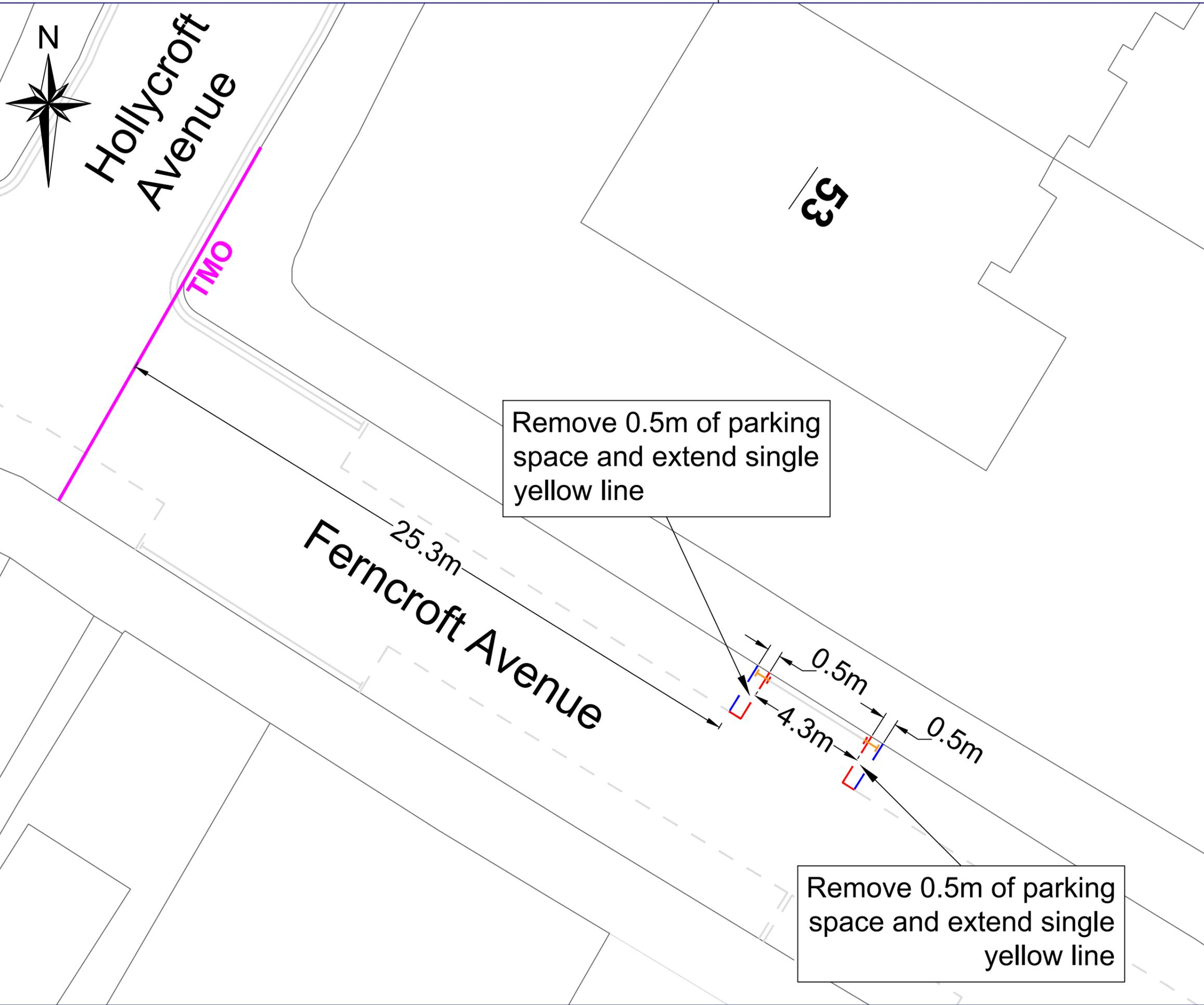

Hollycroft Avenue

TMO

53

25.3m  
Ferncroft Avenue

Remove 0.5m of parking space and extend single yellow line

Remove 0.5m of parking space and extend single yellow line

- KEY**
- Existing parking lines
  - Existing single yellow line restrictions
  - Remove parking lines
  - Install parking lines (TSRGD 1028.4)
  - Install Single Yellow Line restrictions, 50mm yellow lines (TSRGD 1017) Colour to match existing

Rev	By	Date	Amendments

**Camden**  
 Design Team  
 Transport Strategy Service  
 London Borough of Camden  
 5 Pancras Square  
 Tel 020 7974 5551, Fax 020 7974 6952  
 DX 2106 Euston, Minicom 020 7974 6866

Project  
Minor Parking Scheme

Drawing Title  
Restriction Changes  
Hollycroft Avenue (Ferncroft Avenue)  
Consultation Drawing

Scale 1:150	Date Jan 2024
Drawn By MW	File Ref
Checked By	Dwg Name

Drawing Location	Drawing Number Hollycroft Avenue/ 02	Rev.
------------------	---	------



**Proposal:** 6.6m of resident parking bay o/s no. 137 to be converted to a dedicated disabled bay

**Proposal:** 6.6m of resident parking space adjacent to no. 128 to be converted to a general disabled bay

135

6.60m

PERMIT HOLDER XXX ONLY

Iverson Road

6.00m

158

**Proposal:** 6m of general disabled bay o/s no. 158 to be converted to a resident parking bay

6.60m

128

TMO DRAWING

12



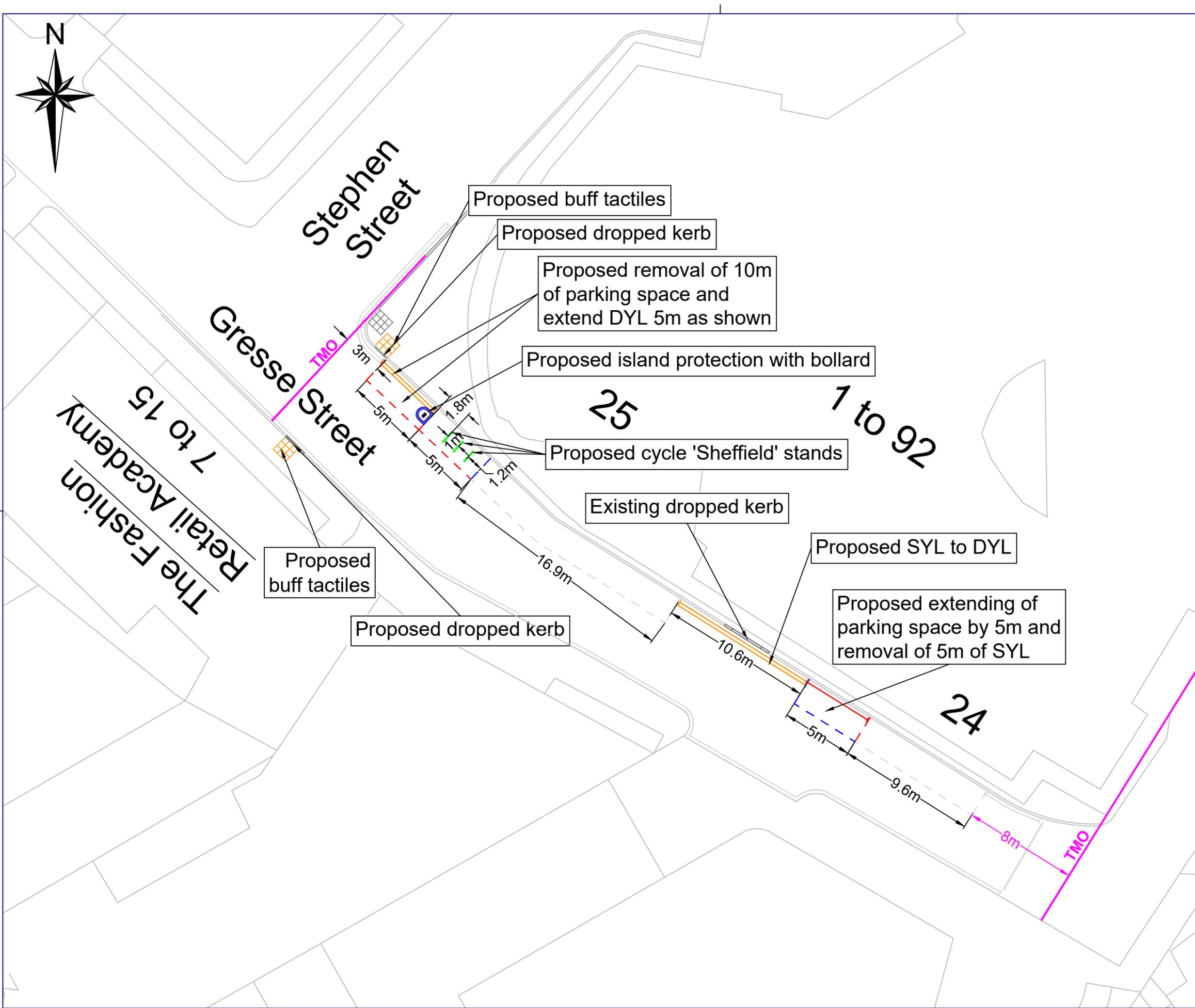

**KEY**

- Existing parking lines
- Existing waiting restrictions
- 50mm yellow lines (TSRGD 1018.1). Colour to match existing
- Remove parking lines
- Install parking lines
- Existing tactiles
- Proposed tactiles
- Proposed transition kerbs and dropper kerb
- Proposed Sheffield Cycle stand
- Proposed cycle protection island with red reflective disc on bollard

- NOTES**
- SYL = Single Yellow Line
  - DYL = Double Yellow Lines
  - Car Bike Port = 4.1m length and 1.375m width

Rev	By	Date	Amendments

**Camden**

Design Team  
 Transport Strategy Service  
 London Borough of Camden  
 5 Pancras Square  
 Tel 020 7974 5551, Fax 020 7974 6952  
 DX 2106 Euston, Minicom 020 7974 6866

Project		Minor Parking Changes
Drawing Title		Parking and Restriction changes Gresse Street Consultation Drawing
Scale	1:250	Date
Drawn By	MW	Dec 2023
Checked By		File Ref
		Dwg Name
Drawing Location		
Drawing Number	Gresse Street/ 02	
		Rev.



MP Moran

Upgrade 27.6m of existing  
timed parking restriction to  
'No Waiting At Any Time'  
restriction

27.6m

TMO

Iverson Road

42

44

**KEY**

- ◆ Existing bollards
- Existing parking lines
- Existing waiting restrictions
- Install 'No Waiting At Any Time'  
restrictions, 50mm yellow lines  
(TSRGD 1018.1). Colour to  
match existing

**NOTES**

- Do not scale off drawing

Rev	By	Date	Amendments



Design Team  
Transport Strategy Service  
London Borough of Camden  
5 Pancras Square  
Tel 020 7974 5551, Fax 020 7974 6952  
DX 2106 Euston, Minicom 020 7974 6866

Project  
Minor Parking Scheme

Drawing Title  
Waiting Restriction Changes  
Iverson Road  
Construction & TMO Drawing

Scale 1:200	Date Dec 2023
Drawn By MW	File Ref
Checked By JA	Dwg Name

Drawing Location	Drawing Number Iverson Road 02 & 03	Rev. A
------------------	--	-----------



Proposed x2 St Pancras bollards with 150mm dia red reflective discs facing the carriageway to be install within the kerbline

Proposed removal of 7.2m of permit holders only parking space and replace with 'No Waiting At Any Time' restrictions

- KEY**
-  Existing road gully
  -  Existing bollard
  -  Install St Pancras bollards with 150mm red reflective discs
  -  Existing DYL
  -  50mm yellow lines (TSRGD 1018.1). Colour to match existing
  -  Existing Parking Lines
  -  Remove Parking Lines
  -  Install Parking Lines

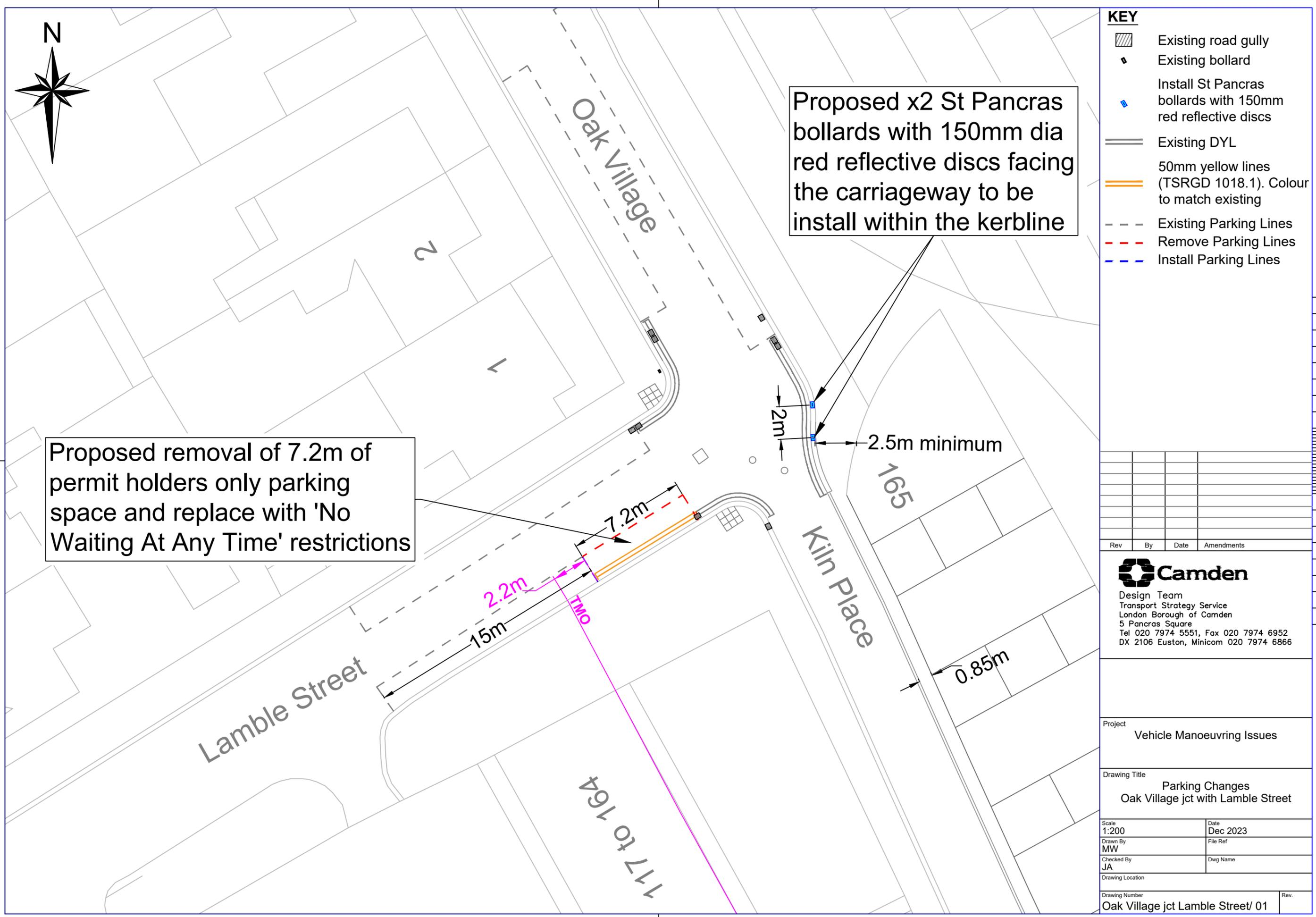

Rev	By	Date	Amendments

**Camden**  
 Design Team  
 Transport Strategy Service  
 London Borough of Camden  
 5 Pancras Square  
 Tel 020 7974 5551, Fax 020 7974 6952  
 DX 2106 Euston, Minicom 020 7974 6866

Project  
 Vehicle Manoeuvring Issues

Drawing Title  
 Parking Changes  
 Oak Village jct with Lamble Street

Scale 1:200	Date Dec 2023
Drawn By MW	File Ref
Checked By JA	Dwg Name
Drawing Location	
Drawing Number Oak Village jct Lamble Street/ 01	Rev.



42 - 53  
Eresby Place

Kingsgate Place

Access road to  
underground carpark  
for 24hrs storage

'No Loading/ Unloading At  
Any Time' parking restrictions

'No Waiting At Any Time'  
parking restrictions

TMO

7.1m

11.7m

12.3m

TMO

22

**Key**

- - - Existing parking lines
- ==== Existing double yellow lines
- ==== Proposed 'No Waiting At Anytime' Lines
- ▨ Proposed 'No Loading/ Unloading At Any Time' markings

Rev	By	Date	Amendments

Rev	By	Date	Amendments

**Camden**  
 Design Team  
 Transport Strategy Service  
 London Borough of Camden  
 5 Pancras Square  
 Tel 020 7974 5551, Fax 020 7974 6952  
 DX 2106 Euston, Minicom 020 7974 6866

Project  
 Proposed 'No waiting and loading  
 at anytime' parking restrictions  
 Kingsgate Place, NW6 4JT

Drawing Title  
 Kingsgate Place  
 Construction/ TMO plan

Scale 1:200 @ A3	Date Oct 2023
Drawn By MW	File Ref
Checked By JA	Dwg Name

Drawing Location T:\Non Capital Schemes\2023-24\MINOR PARKING MEASURES\ Kingsgate PI	
Drawing Number Kingsgate PI\ 02 & 03	Rev.



Remove and dispose of existing splitter timeplate. Replace with splitter bracket with 'Permit holders only' sign (on the left) and 'Disabled Badge Holders only' sign (on the right)

Convert existing dedicated disabled parking bay into a general disabled parking bay

Remove 'Permit Holder 164 Only' markings and install 'DISABLED' markings

**KEY**

-  Existing lining
-  Existing SYL
-  Existing residential parking lines
-  LP 10
-  Remove and dispose splitter timeplate. Install splitter bracket with 'permit holders parking only' sign (on the left) and Disabled badge holders only' sign (on the right)

**Notes**

- Net loss of resident permit parking bays = Zero
- Do not scale off drawing
- DISABLED legend requires 500mm height
- LP = Lamp Post

Rev	By	Date	Amendments



Design Team  
 Transport Strategy Service  
 London Borough of Camden  
 5 Pancras Square  
 Tel 020 7974 5551, Fax 020 7974 6952  
 DX 2106 Euston, Minicom 020 7974 6866

Project  
 Minor Parking Changes  
 o/s 84 Loveridge Road

Drawing Title  
 Convert dedicated disabled parking bay  
 into a general disabled parking bay  
 TMO drawing

Scale 1:150	Date Jan 2024
Drawn By MW	File Ref
Checked By JA	Dwg Name

Drawing Location  
 T:\Non Capital Schemes\2023-24\DEDICATED DISABLED BAYS\GDB12\2023-2024\84 Loveridge Road NW6  
 Drawing Number  
 84 Loveridge Rd/ 02

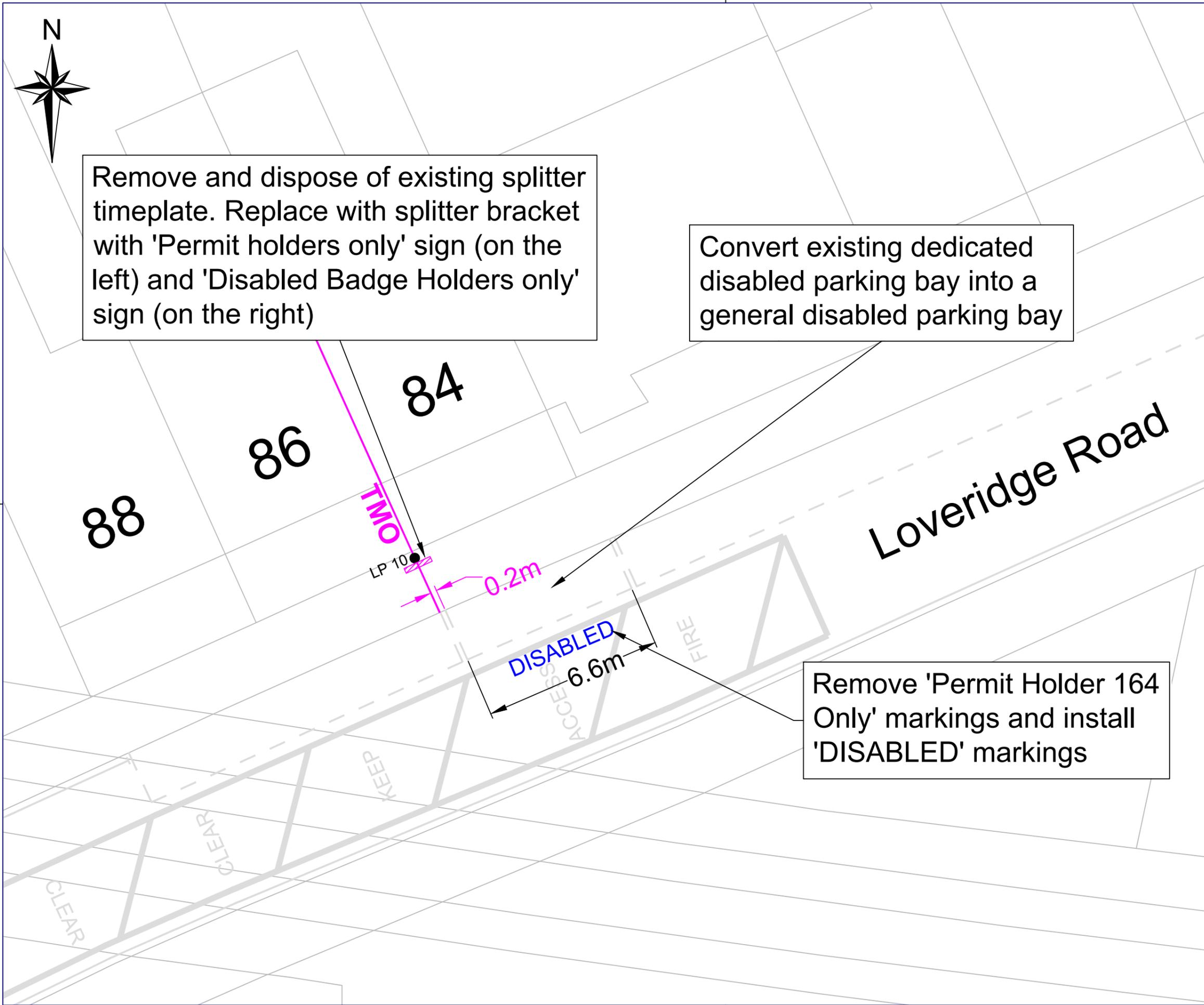



**KEY**

-  Existing waiting restrictions
-  50mm yellow lines (TSRGD 1018.1). Colour to match existing

**NOTES**

- LP = Lamp Post
- Do not scale off drawing

Rev	By	Date	Amendments

Rev	By	Date	Amendments

**Camden**  
 Design Team  
 Transport Strategy Service  
 London Borough of Camden  
 5 Pancras Square  
 Tel 020 7974 5551, Fax 020 7974 6952  
 DX 2106 Euston, Minicom 020 7974 6866

Project  
 Minor Parking Scheme

Drawing Title  
 Waiting Restriction Changes  
 Mansfield Road  
 Construction & TMO Drawing

Scale 1:200	Date Dec 2023
Drawn By MW	File Ref
Checked By JA	Dwg Name

Drawing Location	Drawing Number Mansfield Road 02 & 03	Rev. A
------------------	--	-----------

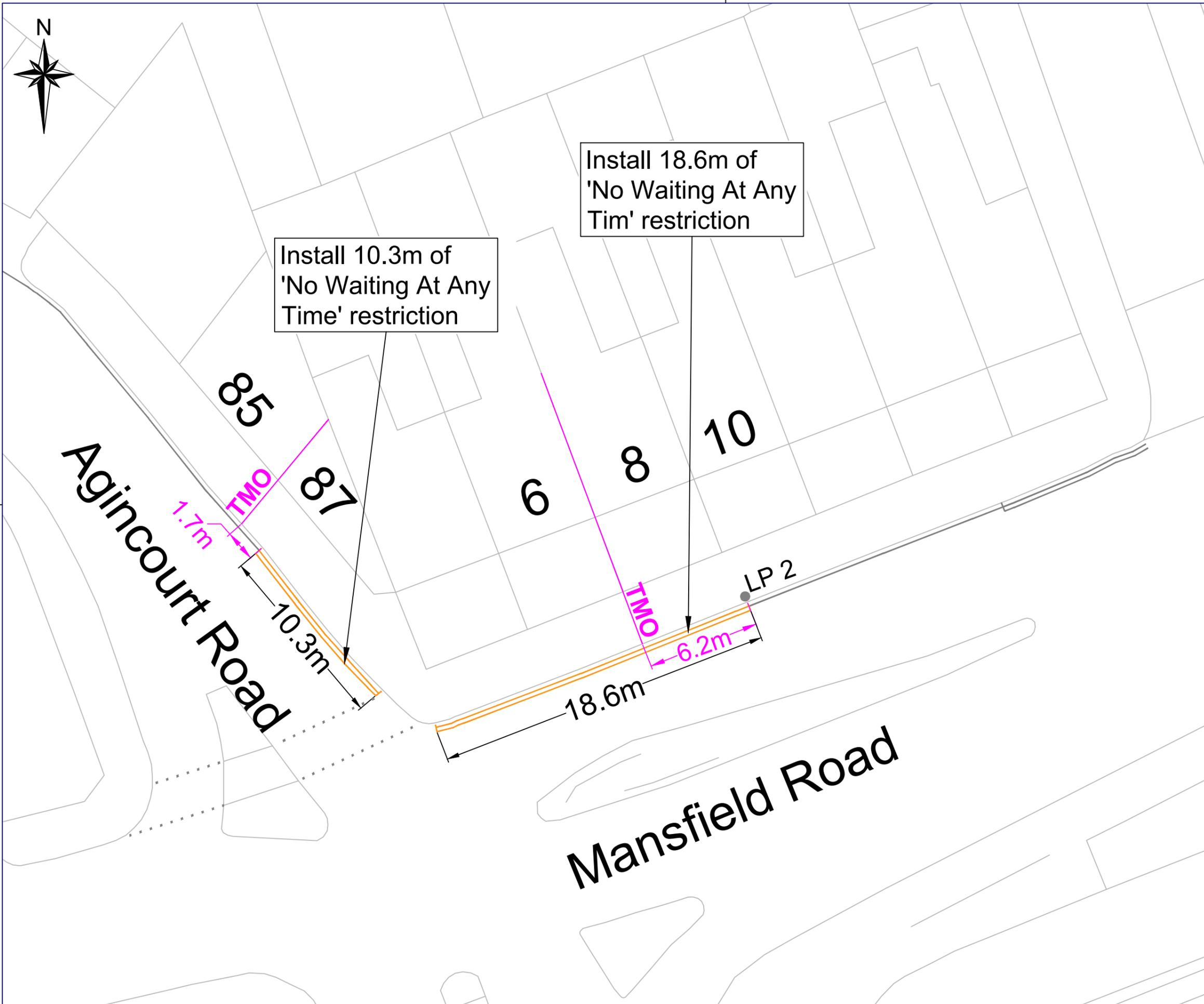

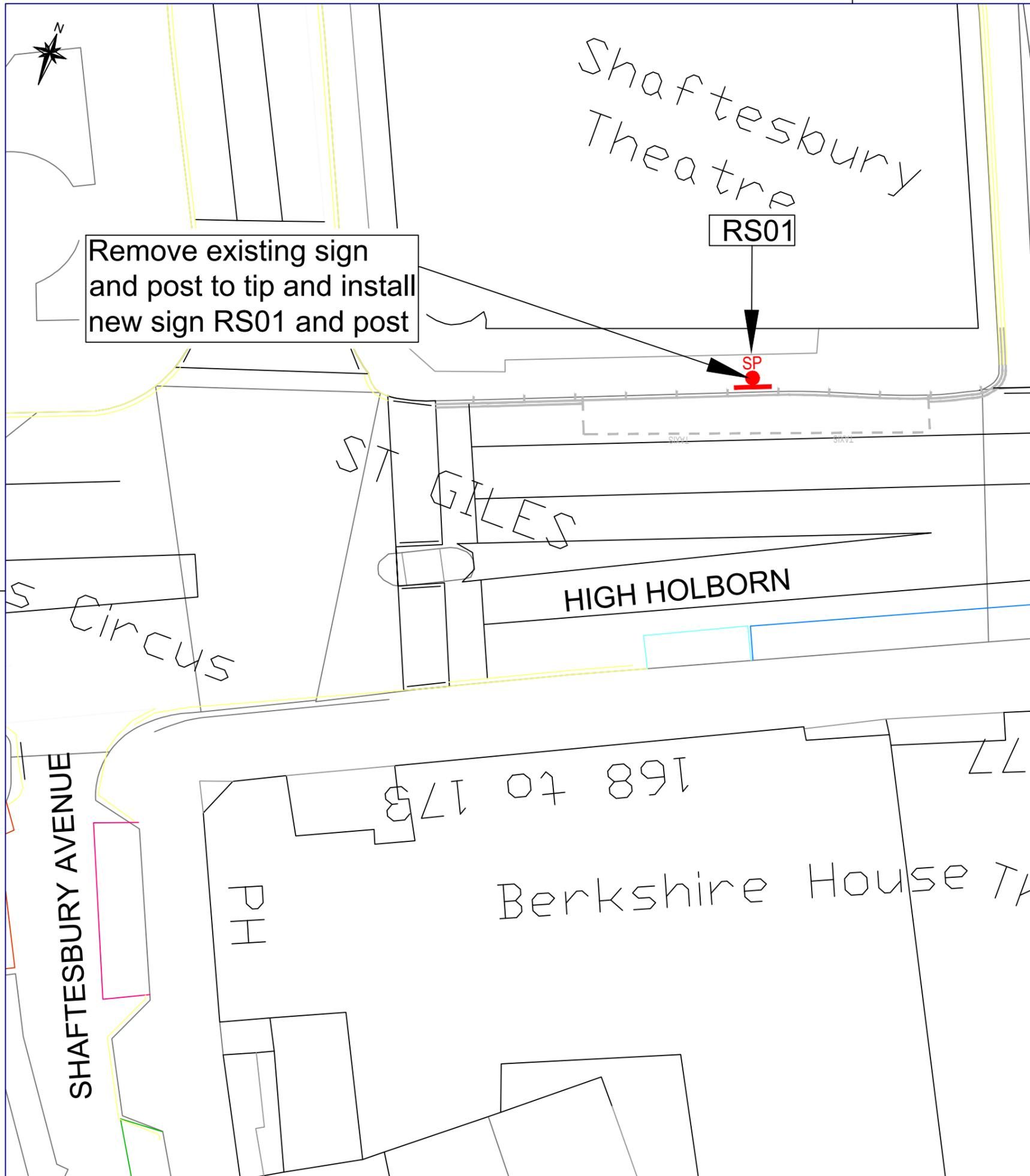

Remove existing sign and post to tip and install new sign RS01 and post

RS01

SP

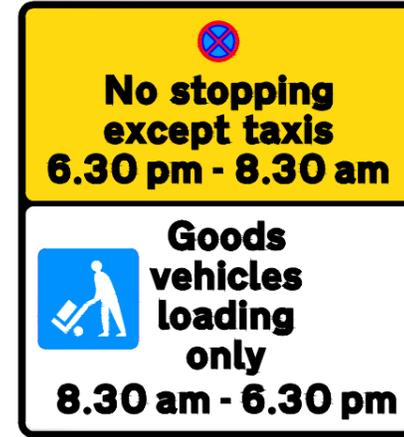

Scheme Ref.		SHAFTESBURY THEATRE	
Sign Ref.	RS01	x-height	20.0
Letter colour	BLACK	SIGN FACE	
Background	WHITE	Width	405 mm
Border	BLACK	Height	440 mm
Material	Class R2	Area	0.18 m <sup>2</sup>

RS01

NOTES

1. DO NOT SCALE FROM THE DRAWING.
2. ALL DIMENSIONS IN METRES UNLESS STATED OTHERWISE.

Rev	By	Date	Amendments
A	HD	19.01.24	Initial issue



Design Team  
 Transport Strategy Service  
 London Borough of Camden  
 5 Pancras Square  
 Tel 020 7974 5551, Fax 020 7974 6952  
 DX 2106 Euston, Minicom 020 7974 6866

Project  
 MINOR PARKING SCHEMES  
 SHAFTESBURY THEATRE  
 SHAFTESBURY AVE, WC2H 8DX

Drawing Title  
 GENERAL ARRANGEMENT  
 SHEET 1 OF 1

Scale 1 : 250 @ A3	Date Jan 2024
Drawn By HD	File Ref MPS-SHAF-THE
Checked By --	Dwg Name MPS-SHAF-THE.dwg

Drawing Location T:\Non Capital Schemes\2023-24\MINOR PARKING MEASURES\Shaftesbury Theatre	Rev. A
Drawing Number MPS-SHAF-THE-0100-0001	



Maintain timed waiting restriction SYL

Change waiting restriction from timed (SYL) to 'No Waiting At Any Time' restrictions

Netherhall Gardens

Install 6.3m of 'No Waiting At Any Time' restrictions

Install 4.9m of 'No Waiting At Any Time' restrictions

Change waiting restriction from timed (SYL) to 'No Waiting At Any Time' restrictions

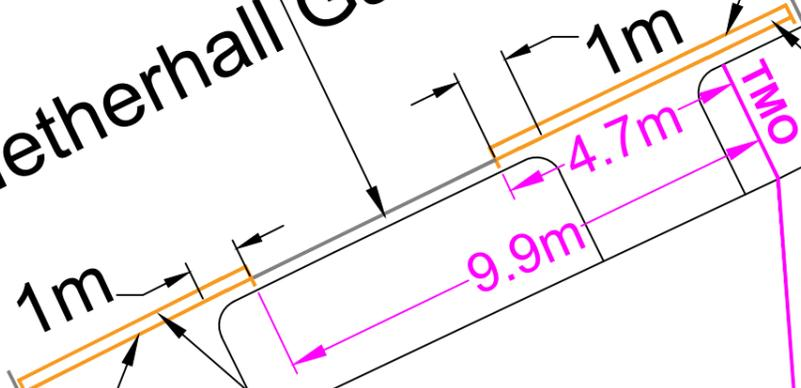

**KEY**

- - Existing parking lines
- Existing waiting restrictions
- 50mm yellow lines (TSRGD 1018.1). Colour to match existing

- NOTES**
- SYL = Single Yellow Lines
  - DYL = Double Yellow Lines
  - Do not scale off drawing

Rev	By	Date	Amendments

**Camden**  
 Design Team  
 Transport Strategy Service  
 London Borough of Camden  
 5 Pancras Square  
 Tel 020 7974 5551, Fax 020 7974 6952  
 DX 2106 Euston, Minicom 020 7974 6866

Project: Minor Parking Scheme

Drawing Title: Waiting restriction changes Netherhall Gardens Construction & TMO drawing

Scale: 1:150	Date: Dec 2023
Drawn By: MW	File Ref:
Checked By: JA	Dwg Name:

Drawing Location: C:\Users\CAMM\OneDrive - London Borough of Camden\Temp\MW\Schemes\Road Safety & Minor Schemes  
 Drawing Number: Netherhall Gardens/ 02 & 03

8E

40



Remove 5m of 'No Waiting At Any Time' restriction and extend permit parking bay by 5m

Remove parking bay and install 'No Waiting At Any Time' restrictions

Remove and dispose of sign and post

Prince Arthur Road

Fitzjohn's Avenue

0.9m  
5m  
2.7m  
TMO

**KEY**

- - Existing parking lines
- Existing waiting restrictions
- 50mm yellow lines (TSRGD 1018.1). Colour to match existing
- - Remove parking lines
- - Install parking lines

**NOTES**

- Do not scale off drawing

Rev	By	Date	Amendments



Design Team  
Transport Strategy Service  
London Borough of Camden  
5 Pancras Square  
Tel 020 7974 5551, Fax 020 7974 6952  
DX 2106 Euston, Minicom 020 7974 6866

Project  
Minor Parking Scheme

Drawing Title  
Waiting restriction changes  
Prince Arthur Road  
Construction & TMO drawing

Scale 1:200	Date Dec 2023
Drawn By MW	File Ref
Checked By JA	Dwg Name

Drawing Location  
C:\Users\CAMM\OneDrive - London Borough of Camden\Temp\MW\Schemes\Road Safety & Minor Schemes

Drawing Number Prince Arthur Road/ 02 & 03	Rev.
---	------

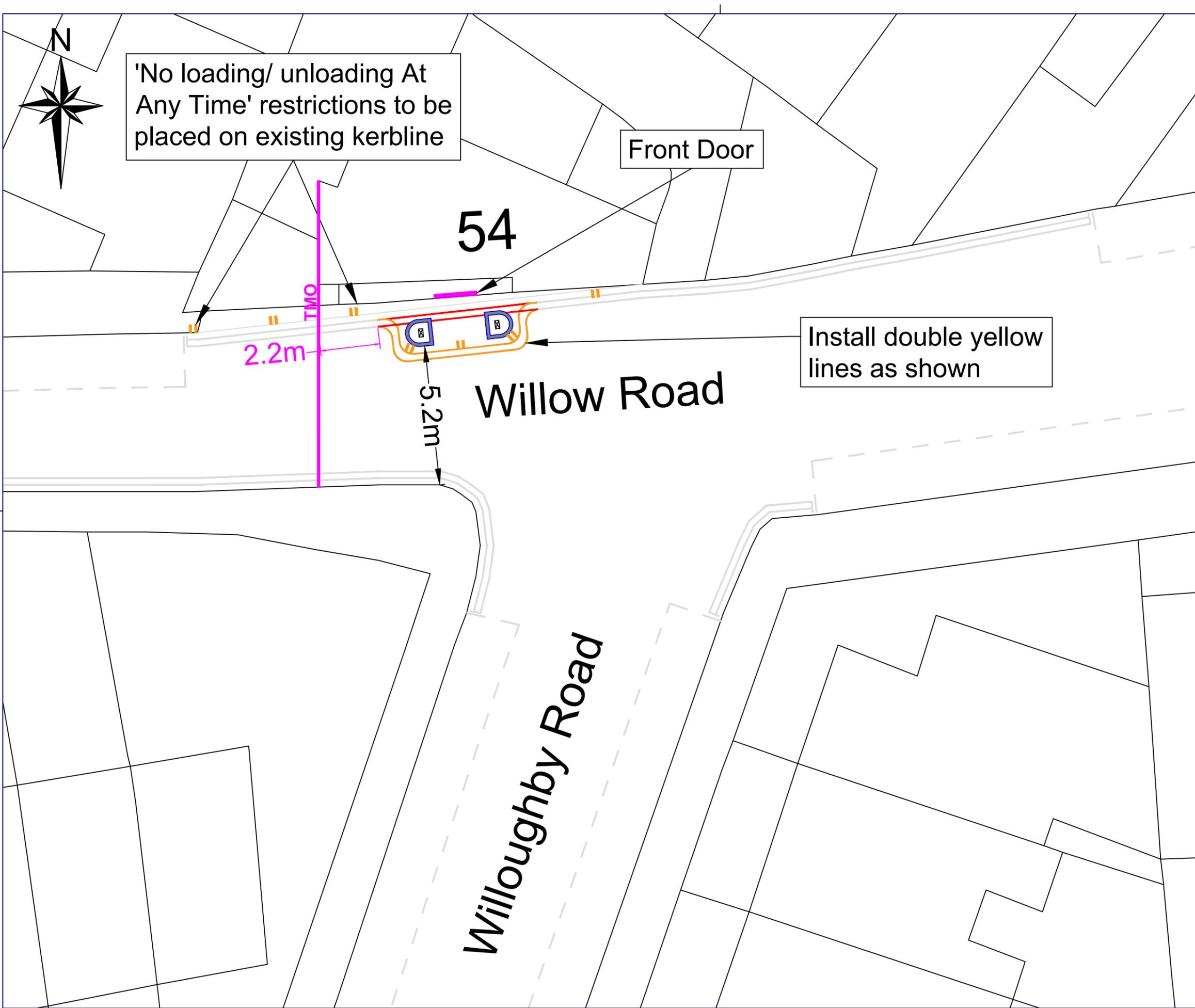

'No loading/ unloading At Any Time' restrictions to be placed on existing kerblines

Front Door

54

TMO

2.2m

5.2m

Willow Road

Willoughby Road

Install double yellow lines as shown

- KEY**
-  Existing parking lines
  -  Remove 'No Waiting At Any Time' restrictions
  -  Existing 'No Waiting At Any Time' restrictions
  -  Install 'No Waiting At Any Time' restrictions
  -  Install 'No Loading/ Unloading At Any Time' restrictions, 100mm yellow lines (TSRGD 1020.1) Colour to match existing

- NOTES**
- 'No Loading/ Unloading At Any Time' restrictions to be laid at 3m intervals on the kerb and on the carriageway as shown in plan

Rev	By	Date	Amendments



Design Team  
 Transport Strategy Service  
 London Borough of Camden  
 5 Pancras Square  
 Tel 020 7974 5551, Fax 020 7974 6952  
 DX 2106 Euston, Minicom 020 7974 6866

Project: Minor Parking Scheme

Drawing Title: Restriction changes Willow Road Consultation Drawing

Scale: 1:150	Date: Jan 2024
Drawn By: MW	File Ref:
Checked By:	Dwg Name:

Drawing Location:

Drawing Number: Willow Road/ 02	Rev:
---------------------------------	------



Install 0.5m transition kerb

Remove and raise 4.7m of dropped & transition kerbing to existing kerbing height

Install post and reuse permit holders only parking sign

Remove 2.7m of permit holders only parking and extend the double yellow lines

Remove and reuse permit holders only parking sign

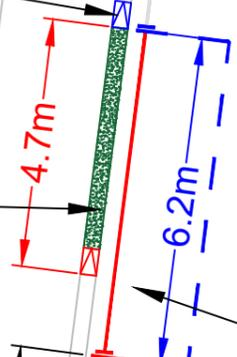

Existing 13.3m of electric vehicle charging space

Remove 6.2m of single yellow line and extend permit holders only parking bay

5.2m of permit holders only parking remaining

Remove 4.8m of permit holders only parking and extend the double yellow lines

TMO

S2

Falkland Road

Leverton Street

**KEY**

- Existing parking bay lining
- Existing yellow lining
- Remove lining
- Install lining
- Install yellow lining (100mm width)
- Install yellow kerb blips lining (100mm width)
- Remove transition kerb
- Existing transition kerb
- Install transition kerb
- Remove & raise dropped kerb
- Install reuse ('permit holders only parking') sign to new post
- Remove 'permit holders only parking' sign to reuse from S2 signpost

Rev	By	Date	Amendments

**Camden**  
 Design Team  
 Transport Strategy Service  
 London Borough of Camden  
 5 Pancras Square  
 Tel 020 7974 5551, Fax 020 7974 6952  
 DX 2106 Euston, Minicom 020 7974 6866

Project  
 Cycle Permeability  
 COVID 19 measures  
 Falkland Road

Drawing Title  
 Construction & TMO Drawing

Scale 1:150	Date Mar 2024
Drawn By MW	File Ref
Checked By JA	Dwg Name
Drawing Location T:\Cptl_Schms\2020-21\Cycle Permeability 20-21\08_Drawings\01_Working Drawings\02_Feasibility	
Drawing Number Falkland Road\ 02	Rev. A

# LONDON BOROUGH OF CAMDEN

## TRAFFIC MANAGEMENT ORDER

202\* No. \*\*\*

---

The Camden (Revocation of Parking Places) (No. \*\*) Traffic Order 202\*

Made on \*\* \*\*\*\*\* 202\*

Coming into force on \*\* \*\*\*\*\* 202\*

---

The Council of the London Borough of Camden, after consulting the Commissioner of Police of the Metropolis, in exercise of the powers conferred by sections 45, 46, 49 and 124 of and Part IV of Schedule 9 to the Road Traffic Regulation Act 1984 [1984 c.27], as amended by section 8 of and part I of schedule 5 to the Local Government Act 1985 [1985 c. 51], and of all other powers thereunto enabling, hereby make the following Order:

### 1. Citation and commencement

- 1.1 This Order may be cited as the Camden (Revocation of Parking Places) (No. \*\*) Traffic Order 202\* and shall come into force on \*\* \*\*\*\*\* 202\*.

### 2. Interpretation

- 2.1 In this Order:

the term "CA-C Order" means the Camden (Parking Places) (CA-C) Traffic Order 2012 [LBC 2012 No. 3];

the term "CA-D Order" means the Camden (Parking Places) (CA-D) Traffic Order 2012 [LBC 2012 No. 4];

the term "CA-H Order" means the Camden (Parking Places) (CA-H) Traffic Order 2012 [LBC 2012 No. 8];

the term "CA-L Order" means the Camden (Parking Places) (CA-L) Traffic Order 2012 [LBC 2012 No. 11];

the term "CA-M Order" means the Camden (Parking Places) (CA-M) Traffic Order 2012 [LBC 2012 No. 12];

the term "CA-P Order" means the Camden (Parking Places) (CA-P) Traffic Order 2012 [LBC 2012 No. 14];

the term "CA-Q Order" means the Camden (Parking Places) (CA-Q) Traffic Order 2012 [LBC 2012 No. 15];

the term "CA-S Order" means the Camden (Parking Places) (CA-S) Traffic Order 2012 [LBC 2012 No. 17];

- 2.2 any reference in this Order to any other Order or enactment shall be construed

as a reference to that Order or enactment as amended, applied, consolidated, re-enacted by, or as having effect by virtue of any subsequent Order or enactment;

- 2.3 unless the context otherwise requires, any expression used in this Order which is also used in the Parent Order shall have the same meaning as in that Order.

### **3. Revocation and designation of parking places**

3.1 Without prejudice to the validity of anything done or to any liability incurred in respect of any act or omission before the coming into force of this Order:

3.2 The **CA-C** order shall have effect as though:

3.2.1 there were omitted from Schedule 1 to that Order, the items set out in table 1.1 of the Schedule to this Order;

3.2.2 there were included in Schedule 1 to that Order, the items set out in table 1.2 of the Schedule to this Order;

3.3 The **CA-D** order shall have effect as though:

3.3.1 there were omitted from Schedule 1 to that Order, the items set out in table 2.1 of the Schedule to this Order;

3.3.2 there were included in Schedule 1 to that Order, the items set out in table 2.2 of the Schedule to this Order;

3.4 The **CA-H** order shall have effect as though:

3.4.1 there were omitted from Schedule 1 to that Order, the items set out in table 3.1 of the Schedule to this Order;

3.4.2 there were included in Schedule 1 to that Order, the items set out in table 3.2 of the Schedule to this Order;

3.5 The **CA-L** order shall have effect as though:

3.5.1 there were omitted from Schedule 1 to that Order, the items set out in table 4.1 of the Schedule to this Order;

3.5.2 there were included in Schedule 1 to that Order, the items set out in table 4.2 of the Schedule to this Order;

3.6 The **CA-M** order shall have effect as though:

3.6.1 there were omitted from Schedule 1 to that Order, the items set out in table 5.1 of the Schedule to this Order;

3.6.2 there were included in Schedule 1 to that Order, the items set out in table 5.2 of the Schedule to this Order;

3.7 The **CA-P** order shall have effect as though:

3.7.1 there were omitted from Schedule 1 to that Order, the items set out in table 6.1 of the Schedule to this Order;

3.7.2 there were included in Schedule 1 to that Order, the items set out in table 6.2 of the Schedule to this Order;

3.8 The **CA-Q** order shall have effect as though:

- 3.8.1 there were omitted from Schedule 1 to that Order, the items set out in table 7.1 of the Schedule to this Order;
- 3.8.2 there were included in Schedule 1 to that Order, the items set out in table 7.2 of the Schedule to this Order;
- 3.9 The **CA-S** order shall have effect as though:
  - 3.9.1 there were omitted from Schedule 1 to that Order, the items set out in table 8.1 of the Schedule to this Order;
  - 3.9.2 there were included in Schedule 1 to that Order, the items set out in table 8.2 of the Schedule to this Order.

**Dated this \*\* \*\*\*\*\* 202\***

**Peter Mardell  
Head of Parking Operations**

TABLE 1.1 – ITEMS OMITTED FROM SCHEDULE 1 TO THE CA-C ORDER

ITEM NUMBER	STREET	LENGTH OF HIGHWAY	CONTROLLED HOURS
356	GRESSE STREET	north-east side: from a point 44.3 metres south-east of the south-eastern kerb line of Stephen Street, south-eastwards for a distance of 11 metres	AT ALL TIMES
11839	GRESSE STREET	north-east side: from a point 3.0 metres south-east of the south-eastern kerb-line of Stephen Street, south-eastwards for a distance of 25.0 metres	AT ALL TIMES

TABLE 1.2 – ITEMS INCLUDED IN SCHEDULE 1 TO THE CA-C ORDER

ITEM NUMBER	STREET	LENGTH OF HIGHWAY	CONTROLLED HOURS
****	GRESSE STREET	north-east side: from a point 45.5 metres south-east of the south-eastern kerb line of Stephen Street, south-eastwards for a distance of 9.6 metres	AT ALL TIMES
****	GRESSE STREET	north-east side: from a point 13.0 metres south-east of the south-eastern kerb-line of Stephen Street, south-eastwards for a distance of 16.9 metres	AT ALL TIMES

TABLE 2.1 – ITEMS OMITTED FROM SCHEDULE 1 TO THE CA-D ORDER

ITEM NUMBER	STREET	LENGTH OF HIGHWAY	CONTROLLED HOURS
14749	BEDFORD ROW	(north-west to south-east arm), the south-west side, from a point 4.0 metres north-west of southern flank wall of no. 44 Bedford Row, north-westwards for a distance of 14.7 metres.	MONDAY – FRIDAY 8.30AM - 6.30PM SATURDAY 8.30AM - 1.30PM

TABLE 2.2 – ITEMS INCLUDED IN SCHEDULE 1 TO THE CA-D ORDER

ITEM NUMBER	STREET	LENGTH OF HIGHWAY	CONTROLLED HOURS
****	BEDFORD ROW	(north-west to south-east arm), the south-west side, from a point 14.0 metres north-west of the north-western kerb-line of Sandland Street, north-westwards for a distance of 10.0 metres.	MONDAY – FRIDAY 8.30AM - 6.30PM SATURDAY 8.30AM - 1.30PM

TABLE 3.1 – ITEMS OMITTED FROM SCHEDULE 1 TO THE CA-H ORDER

ITEM NUMBER	STREET	LENGTH OF HIGHWAY	CONTROLLED HOURS
9287	PRINCE ARTHUR ROAD	north-west side: from a point 7.8 metres south-west of the south-western kerb line of Fitzjohn's Avenue, south-westwards for a distance of 23.7 metres	MONDAY – SATURDAY 9AM - 8PM
3352	PRINCE ARTHUR ROAD	south-east side: from a point 8 metres south-west of the south-western kerb-line of Fitzjohn's Avenue, south-westwards for a distance of 5 metres	MONDAY – SATURDAY 9AM - 8PM

TABLE 3.2 – ITEMS INCLUDED IN SCHEDULE 1 TO THE CA-H ORDER

ITEM NUMBER	STREET	LENGTH OF HIGHWAY	CONTROLLED HOURS
****	PRINCE ARTHUR ROAD	north-west side: from a point 0.9 metres south-west of a point opposite the common boundary of 1 Prince Arthur Road and 77 Fitzjohn's Avenue to the common boundary of No. 16 Prince Arthur Road and No. 79 Fitzjohn's Avenue	MONDAY – SATURDAY 9AM - 8PM

TABLE 4.1 – ITEMS OMITTED FROM SCHEDULE 1 TO THE CA-L ORDER

ITEM NUMBER	STREET	LENGTH OF HIGHWAY	CONTROLLED HOURS
4494	LAMBLE STREET	south side: from a point 4 metres west of the western kerb-line of Kiln Place, westwards for a distance of 22 metres	MONDAY – FRIDAY 8.30AM – 6.30PM

TABLE 4.2 – ITEMS INCLUDED IN SCHEDULE 1 TO THE CA-L ORDER

ITEM NUMBER	STREET	LENGTH OF HIGHWAY	CONTROLLED HOURS
****	LAMBLE STREET	south side: from a point 11.2 metres west of the western kerb-line of Kiln Place, westwards for a distance of 15 metres	MONDAY – FRIDAY 8.30AM – 6.30PM

TABLE 5.1 – ITEMS OMITTED FROM SCHEDULE 1 TO THE CA-M ORDER

ITEM NUMBER	STREET	LENGTH OF HIGHWAY	CONTROLLED HOURS
4746	LEVERTON STREET	west side: from a point 0.5 metres north of the front of no. 13 Falkland Road, northwards for a distance of 11 metres	MONDAY – FRIDAY 8.30AM – 6.30PM
14318	LEVERTON STREET	east side: from a point 4.3 metres south-west of the south-western flank wall of no. 15 Falkland Road, north-eastwards for a distance of 10 metres.	MONDAY – FRIDAY 8.30AM – 6.30PM

TABLE 5.2 – ITEMS INCLUDED IN SCHEDULE 1 TO THE CA-M ORDER

ITEM NUMBER	STREET	LENGTH OF HIGHWAY	CONTROLLED HOURS
****	LEVERTON STREET	west side: from a point 3.2 metres north of the front of no. 13 Falkland Road, northwards for a distance of 14.5 metres	MONDAY – FRIDAY 8.30AM – 6.30PM
****	LEVERTON STREET	east side: from a point 9.1 metres south-west of the south-western flank wall of no. 15 Falkland Road, north-eastwards for a distance of 5.2 metres.	MONDAY – FRIDAY 8.30AM – 6.30PM

TABLE 6.1 – ITEMS OMITTED FROM SCHEDULE 1 TO THE CA-P ORDER

ITEM NUMBER	STREET	LENGTH OF HIGHWAY	CONTROLLED HOURS
12759	AGAMEMNON ROAD	(south-west to north-east arm), the south-east side, from a point 3.5 metres north-east of the eastern kerb-line of Agamemnon Road, north-eastwards for a distance of 84.0 metres, to a point 7.3 metres west of the western kerb line of Ajax Road.	MONDAY – FRIDAY 10AM – NOON

TABLE 6.2 – ITEMS INCLUDED IN SCHEDULE 1 TO THE CA-P ORDER

ITEM NUMBER	STREET	LENGTH OF HIGHWAY	CONTROLLED HOURS
****	AGAMEMNON ROAD	(south-west to north-east arm), the south-east side, from a point 13.8 metres north-east of the eastern kerb-line of Agamemnon Road, to a point 7.3 metres west of the western kerb line of Ajax Road.	MONDAY – FRIDAY 10AM – NOON

TABLE 7.1 – ITEMS OMITTED FROM SCHEDULE 1 TO THE CA-Q ORDER

ITEM NUMBER	STREET	LENGTH OF HIGHWAY	CONTROLLED HOURS
5555	IVERSON ROAD	the north-west side: from the common boundary of nos. 135 and 137 Iverson Road, to a point 1 metre north-east of the common boundary of nos. 143 and 145 Iverson Road	MONDAY – FRIDAY 8.30AM – 6.30PM
5564	IVERSON ROAD	the south-east side, from a point 8 metres north-east of the common boundary of nos. 156 and 158 Iverson Road, to a point 8 metres south-west of the south-western kerb-line build-out of Medley Road.	MONDAY – FRIDAY 8.30AM – 6.30PM
9124	IVERSON ROAD	south-east side: from a point opposite the common boundary of nos. 107 and 109 Iverson Road to a point 2.5 metres east of the common boundary of nos. 142 and 144 Iverson Road, north-eastwards for a distance of 50.5 metres	MONDAY – FRIDAY 8.30AM – 6.30PM

TABLE 7.2 – ITEMS INCLUDED IN SCHEDULE 1 TO THE CA-Q ORDER

ITEM NUMBER	STREET	LENGTH OF HIGHWAY	CONTROLLED HOURS
****	IVERSON ROAD	the north-west side: from a point 6.6 metres north-east of the common boundary of nos. 135 and 137 Iverson Road, to a point 1 metre north-east of the common boundary of nos. 143 and 145 Iverson Road	MONDAY – FRIDAY 8.30AM – 6.30PM
****	IVERSON ROAD	the south-east side, from the common boundary of nos. 156 and 158 Iverson Road, to a point 8 metres south-west of the south-western kerb-line build-out of Medley Road.	MONDAY – FRIDAY 8.30AM – 6.30PM
****	IVERSON ROAD	south-east side: from a point 6.6 metres north-east of a point opposite the common boundary of nos. 107 and 109 Iverson Road to a point 5 metres west of the common boundary of nos. 142 and 144 Iverson Road	MONDAY – FRIDAY 8.30AM – 6.30PM

TABLE 8.1 – ITEMS OMITTED FROM SCHEDULE 1 TO THE CA-S ORDER

ITEM NUMBER	STREET	LENGTH OF HIGHWAY	CONTROLLED HOURS
6103	FERNCROFT AVENUE	north-east side, from a point 17.5 metres south-east from the north-western boundary of no. 53 Hollycroft Avenue, south-eastwards for a distance of 14.0 metres	MONDAY - FRIDAY 12:30PM – 2:30PM
6104	FERNCROFT AVENUE	north-east side, from a point 5.0 metres south-eastwards from the north-western boundary of nos. 53 Hollycroft Avenue, south-westwards for a distance of nos. 12.0 metres	MONDAY - FRIDAY 12:30PM – 2:30PM

TABLE 8.2 – ITEMS INCLUDED IN SCHEDULE 1 TO THE CA-S ORDER

ITEM NUMBER	STREET	LENGTH OF HIGHWAY	CONTROLLED HOURS
****	FERNCROFT AVENUE	north-east side, from a point 18.0 metres south-east from the north-western boundary of no. 53 Hollycroft Avenue, south-eastwards for a distance of 13.5 metres	MONDAY - FRIDAY 12:30PM – 2:30PM
****	FERNCROFT AVENUE	north-east side, from a point 5.0 metres south-eastwards from the north-western boundary of nos. 53 Hollycroft Avenue, south-westwards for a distance of nos. 11.3 metres	MONDAY - FRIDAY 12:30PM – 2:30PM

# **The Camden (Parking Places) (Dedicated Disabled) (Amendment No. \*\*) Traffic Order 202\***

**202\* No. \*\*\***

**GRAFTON ROAD  
IVERSON ROAD  
LOVERIDGE ROAD**

202\* No.  
\*\*\*\*

**LONDON BOROUGH OF CAMDEN**  
**TRAFFIC MANAGEMENT ORDER**

**202\* No. \*\*\***

---

The Camden (Parking Places) (Dedicated Disabled) (Amendment No. \*\*)  
Traffic Order 202\*

Made: \*\* \*\*\*\*\* 202\*

Coming into force: \*\* \*\*\*\*\* 202\*

---

The Council of the London Borough of Camden, after consulting the Commissioner of Police of the Metropolis, in exercise of the powers conferred by sections 45, 46, 49 and 124 of and Part IV of Schedule 9 to the Road Traffic Regulation Act 1984<sup>1</sup>, and of all other powers thereunto enabling, hereby make the following Order:

**Citation and commencement**

1.1 This Order may be cited as the Camden (Parking Places) (Dedicated Disabled) (Amendment No. \*\*) Traffic Order 202\* and shall come into force on \*\* \*\*\*\*\* 202\*.

**Interpretation**

2.1 In this Order:

“enactment” means any enactment, whether public general or local, and includes any order, byelaw, rule, regulation, scheme, or other instrument having effect by virtue of an enactment; and

“the Order of 2012” means the Camden (Parking Places) (Dedicated Disabled) Traffic Order 2012<sup>2</sup>, as amended.

2.2 Any reference in this Order to any other Order or enactment shall be construed as a reference to that Order or enactment as amended, applied, consolidated, re-enacted by, or as having effect by virtue of any subsequent Order or enactment;

2.3 Unless the context otherwise requires, any expression used in this Order which is also used in the Order of 2012 shall have the same meaning as in that Order.

---

<sup>1</sup> 1984 c.27

<sup>2</sup> LBC 2012/23

202\* No.

\*\*\*\*

## **Revocation of parking places**

3.1 Without prejudice to the validity of anything done or to any liability incurred in respect of any act or omission before the coming into force of this Order the Order of 2012 shall have effect as though:-

- (a) there were omitted from the Schedule to that Order, the items numbered 14120 (relating to Grafton Road) and 13739 (relating to Loveridge Road); and
- (b) there were included in Schedule to that Order, the item set out in the Schedule to this Order.

**Dated this \*\* \*\*\*\*\* 202\***

**Peter Mardell**

**Head of Parking Operations**

## SCHEDULE – DEDICATED DISABLED PERSONS PARKING PLACES

ITEM INCLUDED IN THE SCHEDULE TO THE ORDER OF 2012

ITEM NUMBER	STREET	LENGTH OF HIGHWAY	DESIGNATION NUMBER
*****	IVERSON ROAD	the north-west side, from the common boundary of nos. 135 and 137 Iverson Road, to a point 6.6 metres north-east of that boundary.	xxx

# **The Camden (Free Parking Places) (Disabled Persons) (Amendment No. \*\*) Traffic Order 202\***

**202\* No. \*\*\***

**Grafton Road  
Iverson Road  
Loveridge Road**

**LONDON BOROUGH OF CAMDEN**  
**TRAFFIC MANAGEMENT ORDER**

**202\* No. \*\*\***

---

The Camden (Free Parking Places) (Disabled Persons)  
(Amendment No. \*\*) Traffic Order 202\*

Made on \*\* \*\*\*\*\* 202\*

Coming into force on \*\* \*\*\*\*\* 202\*

---

The Council of the London Borough of Camden, after consulting the Commissioner of Police of the Metropolis, in exercise of the powers conferred by sections 6 and 124 of and Part IV of Schedule 9 to the Road Traffic Regulation Act 1984<sup>1</sup>, and of all other powers thereunto enabling, hereby make the following Order:

**Citation and commencement**

1.1 This Order may be cited as the Camden (Free Parking Places) (Disabled Persons) (Amendment No. \*\*) Traffic Order 202\* and shall come into force on \*\* \*\*\*\*\* 202\*.

**Interpretation**

2.1 In this Order:

“enactment” means any enactment, whether public general or local, and includes any order, byelaw, rule, regulation, scheme or other instrument having effect by virtue of an enactment; and

“the Order of 2012” means the Camden (Free Parking Places) (Disabled Persons) Traffic Order 2012<sup>2</sup>, as amended.

2.2 Any reference in this Order to any other Order or enactment shall be construed as a reference to that Order or enactment as amended, applied, consolidated, re-enacted by, or as having effect by virtue of any subsequent Order or enactment.

2.3 Unless the context otherwise requires, any expression used in this Order which is also used in the Order of 2012 shall have the same meaning as in that Order.

---

<sup>1</sup> 1984 c.27

<sup>2</sup> LBC 2012/22

### **3. Amendment of the Order of 2012**

- 3.1 Without prejudice to the validity of anything done or to any liability incurred in respect of any act or omission before the coming into force of this Order the Parent Order shall have effect as though:
  - 3.1.1 there were omitted from the Schedule to that Order, the items set out in table 1 of the Schedule to this Order;
  - 3.1.2 there were included in the Schedule to that Order, the items set out in table 2 of the Schedule to this Order.

**Dated this \*\* \*\*\*\*\* 202\***

**Peter Mardell  
Head of Parking Operations**

## SCHEDULE – PARKING PLACES FOR DISABLED PERSONS (BLUE BADGE HOLDERS)

TABLE 1 – ITEMS OMITTED FROM THE SCHEDULE TO THE PARENT ORDER

ITEM NUMBER	STREET	LENGTH OF HIGHWAY
7102	IVERSON ROAD	the south-east side, from the party wall of nos. 156 and 158 Iverson Road, north-eastwards for a distance of 6 metres.

TABLE 2 – ITEMS INCLUDED IN THE SCHEDULE TO THE PARENT ORDER

ITEM NUMBER	STREET	LENGTH OF HIGHWAY
	GRAFTON ROAD	the south-west side: from a point 7 metres south-east of party wall of nos. 7 and 9 Grafton Road, south-eastwards for a distance of 6.6 metres
	IVERSON ROAD	the south-east side, from a point opposite the common boundary of nos. 107 and 109 Iverson Road to a point 6.6 metres north-east of that point.
	LOVERIDGE ROAD	the north-west side, from the common boundary of nos. 84 and 86 Loveridge Road, north-eastwards for a distance of 6.6 metres

**The Camden (Loading Places) (Amendment No. \*)  
Traffic Order 202\***

**202\* No. \*\*\***

**HIGH HOLBORN**

**LONDON BOROUGH OF CAMDEN**  
**TRAFFIC MANAGEMENT ORDER**

**202\* No. \*\*\***

---

The Camden (Loading Places) (Amendment No. \*\*)  
Traffic Order 202\*

Made on \*\* \*\*\*\* 202\*

Coming into force on \*\* \*\*\*\* 202\*

---

The Council of the London Borough of Camden, after consulting the Commissioner of Police of the Metropolis, in exercise of the powers conferred by sections 6 and 124 of and Part IV of Schedule 9 to the Road Traffic Regulation Act 1984 [1984 c.27], and of all other powers thereunto enabling, hereby make the following Order:

**1. Citation and commencement**

- 1.1 This Order may be cited as the Camden (Loading Places) (Amendment No. \*\*) Traffic Order 202\* and shall come into force on \*\* \*\*\*\* 202\*.

**2. Interpretation**

- 2.1 In this Order:
- 2.1.1 the term "Parent Order" means the Camden (Loading Places) Traffic Order 2012 [LBC 2012 No. 21];
- 2.1.2 any reference in this Order to any other Order or enactment shall be construed as a reference to that Order or enactment as amended, applied, consolidated, re-enacted by, or as having effect by virtue of any subsequent Order or enactment;
- 2.1.3 unless the context otherwise requires, any expression used in this Order which is also used in the Parent Order shall have the same meaning as in that Order.

**3. Revocation and designation of loading places**

- 3.1 Without prejudice to the validity of anything done or to any liability incurred in respect of any act or omission before the coming into force of this Order the Parent Order shall have effect as though:
- 3.1.1 there were omitted from Schedule 1 to that Order, the items set out in table 1 of the Schedule to this Order;
- 3.1.2 there were included in Schedule 1 to that Order, the items set out in table 2 of the Schedule to this Order.

**Dated this \*\* \*\*\*\* 202\***

**Peter Mardell**

**Head of Parking Operations**

## SCHEDULE – LOADING PLACES

TABLE 1 – ITEMS OMITTED FROM SCHEDULE 1 TO THE PARENT ORDER

ITEM NUMBER	STREET	LENGTH OF HIGHWAY	CONTROLLED HOURS
14815	HIGH HOLBORN	north side, from a point 10 metres west of the eastern flank wall of the Shaftesbury Theatre, westwards for a distance of 20 metres.	AT ANY TIME

TABLE 2 – ITEMS INCLUDED IN SCHEDULE 1 TO THE PARENT ORDER

ITEM NUMBER	STREET	LENGTH OF HIGHWAY	CONTROLLED HOURS
	HIGH HOLBORN	north side, from a point 10 metres west of the eastern flank wall of the Shaftesbury Theatre, westwards for a distance of 20 metres.	MONDAY – SUNDAY 8.30AM – 6.30PM

# **The Camden (Taxi Stopping Areas) (No. \*) Traffic Order 202\***

**202\* No. \*\*\***

**High Holborn**

# LONDON BOROUGH OF CAMDEN

## TRAFFIC MANAGEMENT ORDER

202\* No. \*\*\*

---

The Camden (Taxi Stopping Areas) (No. \*) Traffic Order 202\*

Made on \*\* \*\*\*\*\* 202\*

Coming into force on \*\* \*\*\*\*\* 202\*

---

The Council of the London Borough of Camden, after consulting the Commissioner of Police of the Metropolis, in exercise of the powers conferred by sections 6 and 124 of and Part IV of Schedule 9 to the Road Traffic Regulation Act 1984<sup>1</sup>, and of all other powers thereunto enabling, hereby make the following Order:

### Citation and commencement

1.1 This Order may be cited as the Camden (Taxi Stopping Areas) (No. \*) Traffic Order 202\* and shall come into force on \*\* \*\*\*\*\* 202\*.

### Interpretation

2.1 In this Order:-

“causing” includes “permitting”;

“Council” means the Council of the London Borough of Camden;

“enactment” means any enactment, whether public general or local, and includes any order, byelaw, rule, regulation, scheme or other instrument having effect by virtue of an enactment

“taxi” has same meaning as in Schedule 1 to the Traffic Signs Regulations and General Directions 2016<sup>2</sup>;

“no stopping hours”, in relation to a taxi stopping area, means the period specified in column 3 of an item in the Schedule to this Order;

“taxi stopping area” means an area of highway described in column 2 of an item in the Schedule to this Order which is reserved for use by taxis only during the no stopping hours, and in which stopping by vehicles other than taxis is prohibited.

2.2 Any reference in this Order to any enactment shall be construed as a reference to that enactment as amended, applied, consolidated, re-enacted by or as having effect by virtue of any subsequent enactment.

---

<sup>1</sup> 1984 c.27

<sup>2</sup> SI 2016/362

- 2.3 For the purposes of this Order a vehicle shall be deemed to be stopped in a taxi stopping area if the vehicle is stationary and any point of the taxi stopping area is below the vehicle or its load.

### **Restrictions – taxi stopping areas**

- 3.1 No person shall cause any vehicle other than a taxi to stop in a taxi stopping area during the no stopping hours.

### **Exemptions**

- 4.1 Nothing in Article 3.1 shall apply in relation to:-

- (a) to any vehicle being used for fire brigade or police purposes;
- (b) to any vehicle being used in the service of the Council in pursuance of its statutory powers or duties provided that in all the circumstances it is reasonably necessary in the exercise of such powers or in the performance of such duties for the vehicle to stop in a taxi stopping area;
- (c) to any vehicle being used in or adjacent to a taxi stopping area, in connection with any building operation, demolition or excavation, the removal of any obstruction to traffic, the maintenance, improvement, reconstruction, cleansing or lighting of a street, the laying, erection, alteration or repair of any sewer or of any main pipe or apparatus for the supply of gas, water or electricity, or of any electronic communications network, or the placing, maintenance or removal of any traffic sign, if the vehicle cannot conveniently and lawfully be used for that purpose in any part of a street which is not a taxi stopping area during the no stopping hours;
- (d) in any case where the person in control of the vehicle is required by law to stop or is obliged to do so in order to avoid an accident;
- (e) in any case where the person in control of the vehicle is obliged to stop by circumstances beyond that person's control;
- (f) to anything done with the permission or at the direction of a police constable or a civil enforcement officer in uniform.

### **Power to suspend a taxi stopping area**

- 5.1 Any person authorized by the Council or the Chief of Police of the Metropolis may suspend the use of a taxi stopping area or any part thereof whenever that person considers such suspension necessary -

- (a) for the purpose of facilitating the movement of traffic or promoting its safety;
- (b) for any purpose referred to in Article 4.1(b) or (c);
- (c) for the convenience of occupiers of premises adjacent to the taxi stopping area on any occasion of the removal of furniture to or from one office or dwelling-house adjacent to the taxi stopping area from or to a depository, another office or dwelling-house;
- (d) on any occasion on which it is likely by reason of some special attraction that any street will be thronged or obstructed; or

- (e) for the convenience of occupiers of premises adjacent to the taxi stopping area at times of weddings or funerals, or on other special occasions.
- 5.2 A police constable in uniform may suspend for not longer than twenty-four hours the use of a taxi stopping area or any part thereof whenever that person considers such suspension reasonably necessary for the purpose of facilitating the movement of traffic or promoting its safety.
- 5.3 The suspension of a taxi stopping area or part thereof shall be indicated by the placement in or adjacent to the loading place of traffic signage of such type as may be prescribed or authorised under section 64 or 65 of the Road Traffic Regulation 1984 indicating that stopping or waiting by vehicles is prohibited and the Council may temporarily remove or replace any permanent traffic signage in order to convey the same effect.
- 5.4 No person shall cause or permit a vehicle to stop or wait in any part of a taxi stopping area during such period as there is in or adjacent to that taxi stopping area a traffic sign placed in pursuance of Article 5.3.
- 5.5 Nothing in Article 5.4 shall apply in respect of any vehicle which is waiting for any reason specified in Article 5.1(b), (c) or (e) or with the permission of the person suspending the use of all or part of the taxi stopping area or a police constable in uniform or any person duly authorised by the Council.

#### **Placing of traffic signs**

- 6.1 The Council shall:
  - (a) cause the limits of each taxi stopping area to be indicated on the highway by placing and maintaining thereon traffic signs;
  - (b) place and maintain traffic signs in the vicinity of each taxi stopping area indicating that the taxi stopping area may only be used by taxis during the no stopping hours;
  - (c) carry out such other work as is reasonably required for the purpose of the satisfactory operation of a taxi stopping area.

**Dated this \*\* \*\*\*\*\* 202\***

**Peter Mardell**

**Head of Parking Operations**

## SCHEDULE – TAXI STOPPING AREAS

Item No. 1	Taxi Stopping Area 2	No stopping hours 3
1.	<b>HIGH HOLBORN</b> north side, from a point 10 metres west of the eastern flank wall of the Shaftesbury Theatre, westwards for a distance of 20 metres.	Monday to Sunday: Midnight – 8:30 am, 6:30 pm – Midnight

# **The Camden (Waiting and Loading Restrictions) (Civil Enforcement Area) (Amendment No. \*\*\*) Traffic Order 202\***

**202\* No. \*\*\***

**Agamemnon Road  
Agincourt Road  
Bedford Row  
Gresse Street  
Iverson Road  
Kingsgate Place  
Lamble Street  
Leverton Street  
Mansfield Road  
Netherhall Gardens  
Sandland Street  
Willow Road**

**LONDON BOROUGH OF CAMDEN**  
**TRAFFIC MANAGEMENT ORDER**

**202\* No. \*\*\***

---

The Camden (Waiting and Loading Restrictions) (Civil Enforcement Area)  
(Amendment No. \*\*\*) Traffic Order 202\*

Made on \*\* \*\*\*\*\* 202\*

Coming into force on \*\* \*\*\*\*\* 202\*

---

The Council of the London Borough of Camden, after consulting the Commissioner of Police of the Metropolis, in exercise of the powers conferred by sections 6 and 124 of and Part IV of Schedule 9 to the Road Traffic Regulation Act 1984<sup>1</sup>, and of all other powers thereunto enabling, hereby make the following Order:

**Citation and commencement**

1.1 This Order may be cited as the Camden (Waiting and Loading Restrictions) (Civil Enforcement Area) (Amendment No. \*\*\*) Traffic Order 202\* and shall come into force on \*\* \*\*\*\*\* 202\*.

**Interpretation**

2.1 In this Order:-

“enactment” means any enactment, whether public general or local, and includes any order, byelaw, rule, regulation, scheme or other instrument having effect by virtue of an enactment; and

“the Order of 2012” means The Camden (Waiting and Loading Restrictions) (Civil Enforcement Area) Traffic Order 2012<sup>2</sup>, as amended.

2.2 Any reference in this Order to any enactment shall be construed as a reference to that enactment as amended, applied, consolidated, re-enacted by or as having effect by virtue of any subsequent enactment.

2.3 Unless the context otherwise requires, any expression used in this Order which is also used in the Order of 2012 shall have the same meaning as in that Order.

---

<sup>1</sup> 1984 c.27

<sup>2</sup> LBC 2012/1

### **Amendment of the Order of 2012**

3.1 Without prejudice to the validity of anything done or to any liability incurred in respect of any act or omission before the coming into force of this Order, the Order of 2012 shall have effect as though:-

(a) for the items numbered 10, 13, 412, 501, 532, 545, 572, 619 and 677 and set out in Schedule 1 to the Order of 2012, there were substituted the similarly numbered items set out in Schedule 1 to this Order;

(b) for the items numbered 4 and set out in Schedule 2 to the Order of 2012, there were substituted the similarly numbered items set out in Schedule 2 to this Order; and

(c) the items set out in Schedule 3 to this Order, were added to Schedule 2 to the Order of 2012.

**Dated this \*\* \*\*\*\*\* 202\***

**Peter Mardell  
Head of Parking Operations**

## SCHEDULE 1 – WAITING RESTRICTIONS

### ITEMS SUBSTITUTED IN SCHEDULE 1 TO THE ORDER OF 2012

ITEM NUMBER	STREET, SIDE OF STREET and LENGTH OF HIGHWAY	PRESCRIBED HOURS (see Schedule 3 to the Order of 2012)
<b>10</b>	<b>AGAMEMNON ROAD</b>	
(a)	<b>west side:</b>	
(i)	from the northern kerb line of Hillfield Road, northwards for a distance of 8.0 metres	A
(ii)	from a point 15.0 metres south of the southern kerb line of Gondar Gardens to a point 2.0 metres north of the northern kerb line of Gondar Gardens	A
(iii)	from a point 2.0 metres east of the party wall of no.64 and 66 Agamemnon Road, westwards for a distance of 10.4 metres	A
(iv)	from the western kerb line of Ajax Road, westwards for a distance of 3.0 metres	A
(b)	<b>east side:</b>	
(i)	from the northern kerb line of Hillfield Road, northwards for a distance of 10 metres	A
(ii)	from a point 3.9 metres south of the south-east kerb line of Achilles Road to a point 4.5 metres north of the north-west kerb line of Achilles Road	A
(iii)	from a point 4.3 metres south of the south-east kerb line of Ulysses Road to a point 5.7 metres north of the north-west kerb line of Ulysses Road	A

ITEM NUMBER	STREET, SIDE OF STREET and LENGTH OF HIGHWAY	PRESCRIBED HOURS (see Schedule 3 to the Order of 2012)
(iv)	from a point level with the boundary wall of no.37a Agamemnon Road northwards and north-eastwards to a point 13.8 metres north-east of the eastern kerb-line of Agamemnon Road	A
(v)	from the western kerb line of Ajax Road, westwards for a distance of 7.2 metres	A
(c)	<b>both sides:</b> so much else of Agamemnon Road that is public highway and which does not lie within those lengths specified above	J
<b>13</b>	<b>AGINCOURT ROAD</b>	
<b>(a)</b>	<b>north-east side:</b>	
(i)	between the north-eastern kerb line of Mansfield Road and a point 1.7 metres south-east of the common boundary between nos. 85 and 87 Agincourt Road	A
(ii)	between a point 1.7 metres south-east of the common boundary between nos. 85 and 87 Agincourt Road and a point opposite the party wall of nos.33 and 35 Agincourt Road	2N
(iii)	between the eastern kerb line of Cressy Road and a point opposite the party wall of numbers 33 and 35 Agincourt Road	A
(iv)	from the north-west kerb line of Cressy Road to its junction with Constantine Road	2N
<b>(b)</b>	<b>south-west side:</b>	
(i)	between the northern kerb line of Fleet Road and a point 21 metres south-east of the south-eastern kerb line of Cressy Road	2N
(ii)	between a point 3 metres west of a point opposite the party wall of nos. 34 and 36 Agincourt Road and a point 21 metres south-east of the south-eastern kerb line of Cressy Road	A

ITEM NUMBER	STREET, SIDE OF STREET and LENGTH OF HIGHWAY	PRESCRIBED HOURS (see Schedule 3 to the Order of 2012)
(iii)	from a point 3.0 metres west of a point opposite the party wall of nos.34 and 36 Agincourt Road to the junction with Constantine Road	2N
<b>412</b>	<b>GRESSE STREET</b>	
(a)	<b>north and north-east side:</b>	
(i)	from a point 7.3 metres north-west of the north-western kerb line of Stephen Street to a point 13.0 metres south-east of the south-eastern kerb line of Stephen Street	A
(ii)	from a point 29.9 metres south-east of the south-eastern kerb line of Stephen Street to a point 40.5 metres south-east of that kerb-line	A
(b)	<b>both sides:</b> so much else of Gresse Street that is public highway and which does not lie within those lengths specified above	F
<b>501</b>	<b>IVERSON ROAD</b>	
(a)	<b>north and north-west side:</b>	
(i)	between the western kerb line of West End Lane and a point 28.2 metres east of a point opposite the common boundary of nos. 212 and 214 Iverson Road	A
(ii)	between a point 28.2 metres east of a point opposite the common boundary of nos. 212 and 214 Iverson Road and a point opposite the common boundary of nos. 180 and 182 Iverson Road	B
(iii)	between a point opposite the common boundary of nos. 180 and 182 Iverson Road and a point 7.0 metres north-east of the common boundary of nos. 143 and 145 Iverson Road	A

ITEM NUMBER	STREET, SIDE OF STREET and LENGTH OF HIGHWAY	PRESCRIBED HOURS (see Schedule 3 to the Order of 2012)
(iv)	between a point 7 metres north-east of the common boundary of nos. 143 and 145 Iverson Road and the party wall of nos. 135 and 137 Iverson Road	B
(v)	between the party wall of nos. 135 and 137 Iverson Road and a point 3.5 metres north-east of the party wall of nos. 121 and 123 Iverson Road	A
(vi)	between a point 3.5 metres north-east of the party wall of nos. 121 and 123 Iverson Road and a point 2 metres south-west of the party wall of nos. 75 and 77 Iverson Road	B
(vii)	between a point 2 metres south-west of the party wall of nos. 75 and 77 Iverson Road and a point 1 metre south-west of the common boundary of nos. 71 and 73 Iverson Road	A
(viii)	between a point 1 metre south-west of the common boundary of nos. 71 and 73 Iverson Road and a point opposite the common boundary of Nos. 42 and 44 Iverson Road	B
(ix)	between a point opposite the common boundary of Nos. 42 and 44 Iverson Road and a point 27.6 metres south-west of a point opposite that boundary	A
(x)	between a point 27.6 metres south-west of a point opposite the common boundary of Nos. 42 and 44 Iverson Road and a point 40 metres north-east of the north-eastern kerb line of Kilburn High Road	B
(xi)	between a point 40 metres north-east of the north-eastern kerb line of Kilburn High Road and that kerb line	A
(b)	<b>south and south-east side:</b>	
(i)	between the western kerb line of West End Lane and the eastern kerb line of Rowntree Close	A
(ii)	between the western kerb line of Rowntree Close and a point 10 metres south-west of the party wall of nos. 180 and 182 Iverson Road	B
(iii)	from a point 10 metres south-west of the party wall of nos. 180 and 182 Iverson Road to the eastern kerb line of Medley Road	A

ITEM NUMBER	STREET, SIDE OF STREET and LENGTH OF HIGHWAY	PRESCRIBED HOURS (see Schedule 3 to the Order of 2012)
(iv)	from the western kerb line of Medley Road, westwards for a distance of 7.3 metres	A
(v)	between a point 7.3 metres west of the western kerb line of Medley Road and the party wall of nos. 135 and 137 Iverson Road	B
(vi)	between the party wall of nos. 135 and 137 Iverson Road and a point 32 metres south-west of that party wall	A
(vii)	between a point 32 metres south-west of the party wall of nos. 135 and 137 Iverson Road and the party wall of nos. 92 and 94 Iverson Road	B
(viii)	between the party wall of nos. 92 and 94 Iverson Road and the party wall of nos. 84 and 86 Iverson Road	A
(ix)	between the party wall of nos. 84 and 86 Iverson Road and the party wall of no. 2a Iverson Road and no. 338 Kilburn High Road	B
(x)	between the party wall of no. 2a Iverson Road and no. 338 Kilburn High Road and the north-eastern kerb line of Kilburn High Road	A
<b>532</b>	<b>KINGSGATE PLACE</b>	
(a)	<b>south and south-west side:</b>	
(i)	from the south-western kerb line of Kingsgate Road, south-westwards for a distance of 31 metres	A
(ii)	from the north-east kerb line of Kilburn High Road, north-eastwards for a distance of 5.9 metres	A
(iii)	from a point 2.0 metres north of the northern flank wall of no.22 Kingsgate Place, south-eastwards for a distance of 114 metres	A
(b)	<b>north-west and north-east side:</b>	

ITEM NUMBER	STREET, SIDE OF STREET and LENGTH OF HIGHWAY	PRESCRIBED HOURS (see Schedule 3 to the Order of 2012)
(i)	from a point 7.1 metres south-east of the southern wall of 42-53 Eresby Place to a point 18.8 metres south-east of that wall	A
(ii)	from the north-eastern kerb line of Kilburn High Road to the north-eastern kerb-line of Kingsgate Place (north-west to south-east arm)	A
(c)	so much else of Kingsgate Place that is public highway and which does not lie within those lengths specified above	B
<b>545</b>	<b>LAMBLE STREET</b>	
(a)	<b>north to south arm: east side:</b>	
(i)	between the northern kerb line of Elaine Grove and a point 10 metres south of the southern kerb line of Elaine Grove	A
(ii)	between a point 13 metres north of the northern kerb line of the east to west arm of Lamble Street and a point 10 metres east of the eastern kerb line of the north to south arm of Lamble Street	A
(b)	<b>east to west arm: north side</b>	
(i)	between a point 4 metres west of the western kerb line of Julia Street and a point 4 metres east of the eastern kerb line of Julia Street	A
(ii)	between a point 7 metres west of the western kerb line of the north to south arm of the western section of Oak Village and a point 4 metres east of the eastern kerb line of the north to south arm of the western section of Oak Village	A
(iii)	north side: between the western kerb line of the north to south arm of the eastern section of Oak Village and a point 4 metres west of that kerb line	A
(c)	<b>east to west arm: south side</b>	

ITEM NUMBER	STREET, SIDE OF STREET and LENGTH OF HIGHWAY	PRESCRIBED HOURS (see Schedule 3 to the Order of 2012)
(i)	between a point 7 metres west of the western kerb line of Grafton Road and a point 17 metres east of the eastern kerb line of Grafton Road	A
(ii)	between the south-western kerb line of Kiln Place and a point 11.2 metres west of that kerb line	A
(d)	both sides: so much else of Lambie Street that is public highway and which does not lie within those lengths specified above	B
<b>572</b>	<b>LEVERTON STREET</b>	
(a)	<b>east side:</b>	
(i)	between the northern kerb line of Leighton Road and a point opposite the party wall of nos. 30 and 32 Leverton Street	A
(ii)	between a point opposite the party wall of nos. 30 and 32 Leverton Street and a point 3 metres south of the southern kerb line of Falkland Road	B
(iii)	between a point 3 metres south of the southern kerb line of Falkland Road and a point 9.3 metres north of the northern kerb line of Falkland Road	A
(iv)	between a point 9.3 metres north of northern kerb line of Falkland Road and a point 3 metres north of the party wall of nos. 68 and 70 Leverton Street	B
(v)	between a point 3 metres north of the party wall of nos. 68 and 70 Leverton Street and the southern kerb line of Countess Road	A
(vi)	between the northern kerb line of Countess Road and a point 3.0 metres south of the party wall of no. 72 and 74 Leverton Street	A
(vii)	between a point 3.0 metres south of the party wall of no. 72 and 74 Leverton Street and a point opposite the party wall of no.88 and 90 Leverton Street	B

ITEM NUMBER	STREET, SIDE OF STREET and LENGTH OF HIGHWAY	PRESCRIBED HOURS (see Schedule 3 to the Order of 2012)
(viii)	between a point opposite the party wall of no.88 and 90 Leverton Street and the southern kerb line of Ospringe Road	A
(b)	<b>west side:</b>	
(i)	between its junction with Leighton Road and a point 17 metres north of that junction	B
(ii)	between a point 17 metres north of the northern kerb line of Leighton Road and a point 23.5 metres north of that kerb line	A
(iii)	between a point 23.5 metres north of the northern kerb line of Leighton Road and a point 4 metres south of the southern kerb line of Falkland Road	B
(iv)	between a point 4 metres south of the southern kerb line of Falkland Road and a point 7.2 metres north of the northern kerb line of Falkland Road	A
(v)	between a point 7.2 metres north of the northern kerb line of Falkland Road and the southern kerb line of the south arm of Railey Mews	B
(vi)	between the southern kerb line of south arm of Railey Mews and a point 2 metres north of the northern kerb line of Railey Mews	A
(vii)	between a point 2 metres north of the northern kerb line of the south arm of Railey Mews and a point 7 metres south of the southern kerb line of north arm of Railey Mews	B
(viii)	between a point 7 metres south of the southern kerb line of north arm of Railey Mews and that kerb line	A
<b>619</b>	<b>MANSFIELD ROAD</b>	
(a)	<b>north side:</b>	

ITEM NUMBER	STREET, SIDE OF STREET and LENGTH OF HIGHWAY	PRESCRIBED HOURS (see Schedule 3 to the Order of 2012)
(i)	from the north-eastern kerb line of Agincourt Road to a point 6.2 metres north-east of the common boundary of nos. 6 and 8 Mansfield Road	A
(ii)	from a point 6.2 metres north-east of the common boundary of nos. 6 and 8 Mansfield Road to a point 10 metres south-west of the south-western kerb line of Roderick Road north-eastwards to the south-western kerb line of Roderick Road	E
(iii)	from a point 10 metres south-west of the south-western kerb line of Roderick Road to a point 14 metres north-east of the north-eastern kerb line of Roderick Road	A
(iv)	from a point 14 metres north-east of the north-eastern kerb line of Roderick Road to the south-western kerb line of Estelle Road	2N
(v)	from the north-eastern kerb line of Estelle Road, north-eastwards to a point 3.73 metres east of the western flank wall of no.84 Mansfield Road	A
(vi)	from a point 3.73 metres east of the western flank wall of no. 84 Mansfield Road to a point 3.76 metres west of the eastern flank wall of no.104 Mansfield Road	2N
(vii)	from to a point 3.76 metres west of the eastern flank wall of no.104 Mansfield Road to a point 4.49 metres east of the eastern kerb line of Rona Road	A
(viii)	from a point 4.49 metres east of the eastern kerb line of Rona Road to a point 3.88 metres west of the western kerb line of Savernake Road	2N
(ix)	from to a point 3.88 metres west of the eastern flank wall of no.128 Mansfield Road to a point 3.75 metres east of the eastern kerb line of Savernake Road	A
(x)	from a point 3.75 metres east of the eastern kerb line of Savernake Road to a point opposite the south-western kerb line of the eastern arm of Oak Village	2N
(b)	<b>south side:</b>	

ITEM NUMBER	STREET, SIDE OF STREET and LENGTH OF HIGHWAY	PRESCRIBED HOURS (see Schedule 3 to the Order of 2012)
(i)	from the junction with Southampton Road, eastwards for a distance of 60 metres	E
(ii)	from a point 60 metres east of the junction with Southampton Road to the south-western kerb line of the eastern arm of Oak Village	2N
<b>677</b>	<b>NETHERHALL GARDENS</b>	
(a)	<b>north-west and west side:</b>	
(i)	between a point opposite the common boundary of nos. 2 and 4 Netherhall Gardens and its south-western extremity	A
(ii)	between and a point opposite the common boundary of nos.2 and 4 Netherhall Gardens and a point 60.2 metres south of a point 1.0 metre north of the common boundary of 7A and 9 Netherhall Gardens	2N
(iii)	from a point 50.3 metres south of a point 1.0 metre north common boundary of 7A and 9 Netherhall Gardens and a point 60.2 metres south of that point	A
(iv)	from a point 10 metres south of the common boundary of 7a and 9 Netherhall Gardens and a point 50.3 metres south of that point	2N
(v)	from a point 1.0 metre north common boundary of 7a and 9 Netherhall Gardens and a point 10 metres south of that point	A
(vi)	from a point 1.0 metre north common boundary of 7a and 9 Netherhall Gardens and its junction with Fitzjohns Avenue	2N
(b)	<b>south-east and east side:</b>	
(i)	between a point opposite the common boundary of nos. 2 and 2a Netherhall Gardens and its south-western extremity	A

ITEM NUMBER	STREET, SIDE OF STREET and LENGTH OF HIGHWAY	PRESCRIBED HOURS (see Schedule 3 to the Order of 2012)
(ii)	between a point opposite the common boundary of nos. 2 and 2A Netherhall Gardens and a point 61.2 metres south of the southern kerb line of Nutley Terrace	2N
(iii)	from a point 61.2 metres south of the southern kerb line of Nutley Terrace and a point 51.3 metres south of that kerb line	A
(iv)	from a point 11.9 metres south of the southern kerb line of Nutley Terrace and a point 51.3 metres south of that kerb line	2N
(v)	from the southern kerb line of Nutley Terrace and a point 11.9 metres south of that kerb line	A
(vi)	from the northern kerb line of Nutley Terrace and a point 10 metres north of that kerb line	A
(vii)	from a point 10 metres north of the northern kerb line of Nutley Terrace to a point 14.8 metres south-west of the common boundary between Nos. 38 and 40 Netherhall Gardens	2N
(viii)	from a point 14.8 metres south-west of the common boundary between Nos. 38 and 40 Netherhall Gardens to a point 9.9 metres south-west of that boundary	A
(ix)	from a point 9.9 metres south-west of the common boundary between Nos. 38 and 40 Netherhall Gardens to a point 4.7 metres south-west of that boundary	2N
(x)	from a point 4.7 metres south-west of the common boundary between Nos. 38 and 40 Netherhall Gardens to a point 1.6 metres north-east of that boundary	A
(xi)	from a point 1.6 metres north-east of the common boundary between Nos. 38 and 40 Netherhall Gardens to its junction with Fitzjohns Avenue	2N

## SCHEDULE 2 – LOADING RESTRICTIONS

### ITEMS SUBSTITUTED IN SCHEDULE 2 TO THE ORDER OF 2012

ITEM NUMBER	STREET, SIDE OF STREET and LENGTH OF HIGHWAY	PRESCRIBED HOURS (see Schedule 3 to the Order of 2012)
	<b>LEVERTON STREET</b>	
(a)	<b>east side:</b> between a point 3 metres south of the southern kerb line of Falkland Road and a point 9.3 metres north of northern kerb line of Falkland Road	1
(b)	<b>west side:</b> between a point 4 metres south of the southern kerb line of Falkland Road and a point 7.2 metres north of the northern kerb line of Falkland Road	1
<b>186A</b>	<b>SANDLAND STREET</b>	
(a)	<b>both sides:</b> from the eastern kerb line of Red Lion Street to a point 7.8 metres east of that kerb-line	
(b)	<b>north side:</b> from the western kerb-line of Bedford Row (north-west to south-east arm) to a point 6 metres west of that kerb-line	1
(c)	<b>south side:</b> from a point 7.5 metres west of the common boundary of Nos. 45 and 46 Bedford Row to its junction with Bedford Row	1

### SCHEDULE 3 – LOADING RESTRICTIONS

#### ITEMS ADDED TO SCHEDULE 2 TO THE ORDER OF 2012

ITEM NUMBER	STREET, SIDE OF STREET and LENGTH OF HIGHWAY	PRESCRIBED HOURS (see Schedule 3)
	<b>BEDFORD ROW</b>	
	<b>east to west arm:</b>	
(a)	<b>north side:</b> from the eastern kerb-line of Bedford Row (north-west to south-east arm) to a point 2.9 metres east of that kerb-line	1
(b)	<b>south side:</b> from a point opposite a point 2.9 metres east of the eastern kerb-line of Bedford Row (north-west to south-east arm) to its junction with Sandland Street	1
	<b>north-west to south-east arm:</b>	
	<b>north-east side:</b>	
(i)	from the northern kerb-line of Bedford Row (east to west arm) to a point 21.9 metres north-west of that kerb-line	1
	<b>south-west side:</b>	
(i)	from the northern kerb-line of Bedford Row (east to west arm) to a point 14.0 metres north-west of that kerb-line	1
	<b>KINGSGATE PLACE</b>	

ITEM NUMBER	STREET, SIDE OF STREET and LENGTH OF HIGHWAY	PRESCRIBED HOURS (see Schedule 3)
	<b>the north-east side:</b> from a point 7.1 metres south-east of the southern wall of 42-53 Eresby Place to a point 18.8 metres south-east of that wall	1
	<b>WILLOW ROAD</b>	
	<b>the north side:</b> from the common boundary of Nos. 53 and 54 Willow Road to a point 15.2 metres east of that boundary	1